

BT-770 Patient monitor Operation Manual

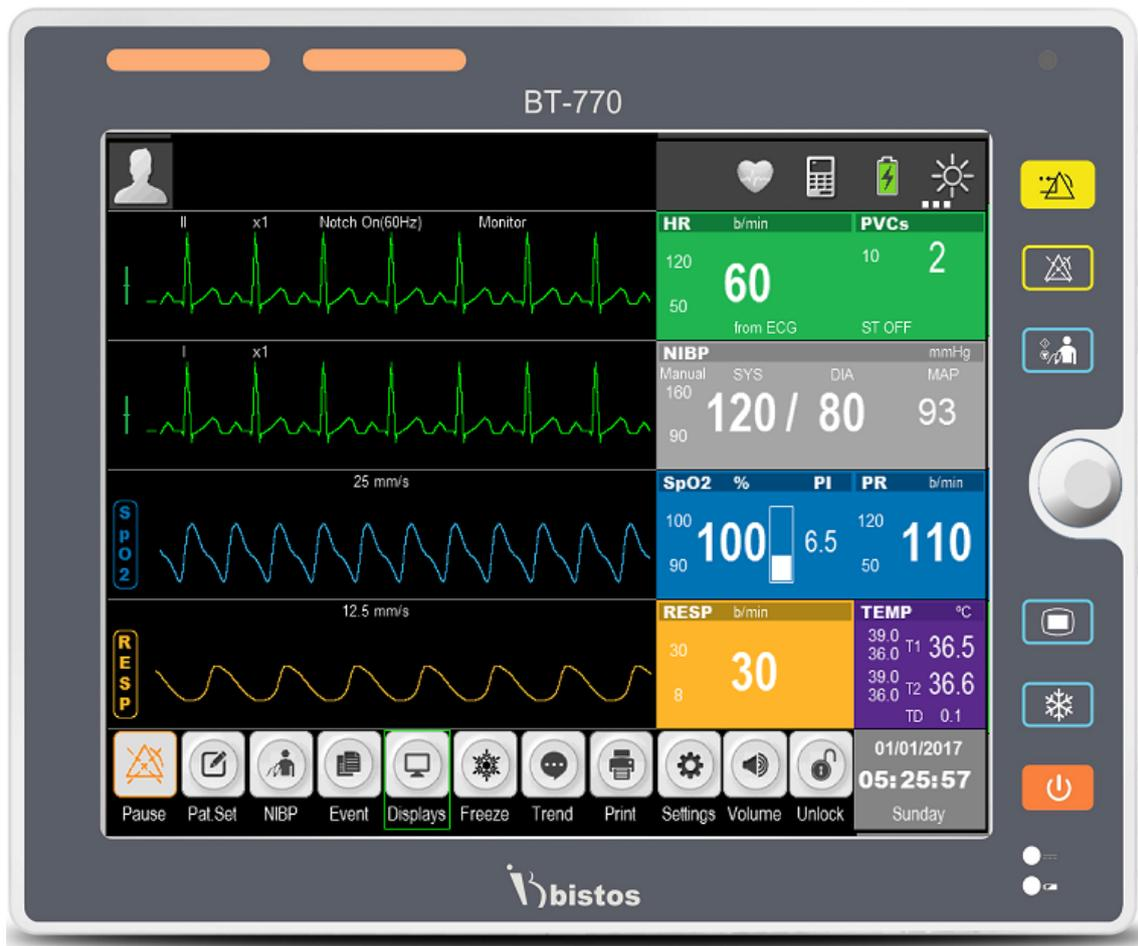

Keep this manual for future reference

P/N : 770-ENG-OPM-EUR-R00

Proprietary Material

Information and descriptions contained in this manual are the property of Bistos Co., Ltd. and may not be copied, reproduced, disseminated, or distributed without express written permission from Bistos Co., Ltd.

Information furnished by Bistos Co., Ltd is believed to be accurate and reliable. However, no responsibility is assumed by Bistos for its use, or any infringements of patents or other rights of third parties that may result from its use. No license is granted by implication or otherwise under any patent or patent rights of Bistos Co., Ltd.

The information contained herein is subjects to change without notice.

Prepared by:

Bistos Co., Ltd.
7th FL., A Bldg., Woolim Lions Valley 5-cha,
302, Galmachi-ro, Jungwon-gu, Seongnam-si,
Gyeonggi-do, Korea

Telephone: +82 31 750 0340

Fax: +82 31 750 0344

Revision R00
September, 2018

Printed in Korea
Copyright © Bistos Corporation 2018. All rights reserved.

Contents

0. Safety information	6
0.1 General precautions, warnings and cautions	9
0.2 Shock hazards	13
0.3 Battery warnings	14
0.4 General precautions on environment	15
1. System basics	16
1.1 Intended use	16
1.2 Operating principle	18
1.3 System configurations	19
1.4 Product outlook	21
1.5 Description of monitor	23
1.6 Understanding the display	27
1.7 Smart Hotkeys	28
1.8 Essential performance	28
2. Preparing for operation	29
2.1 Installation	29
2.2 Connecting to power	31
3. Basic operations	32
3.1 Turn on	32
3.2 Turn off	33
3.3 Basic operations	33
3.4 Operation mode	36
3.5 Measurement setup	36
3.6 Freezing waves	37
3.7 Other common setup	37
4. Patient information management	41
4.1 Patient setup menu	41
4.2 Admitting a patient	42
4.3 Patient information	43
4.4 Discharging a patient	44
4.5 Clear alarms	44
4.6 Clear trend	44
4.7 Clear NIBP trend	45
5. Display format	46
5.1 Selecting user interface	46
5.2 Display description	47
6. Alarm	50
6.1 Alarm types	50
6.2 Alarm condition priorities	50
6.3 Alarm mode	51

6.4 Alarm states	53
6.5 Alarm setup	56
6.6 Latch alarm	58
6.7 Manual event	59
6.8 Alarm record	59
7. ECG	60
7.1 Overview	60
7.2 Safety information	61
7.3 Monitoring steps	62
7.4 ECG display	66
7.5 ECG setup	67
7.6 Alarm setup	68
8. RESP	69
8.1 Overview	69
8.2 Safety information	69
8.3 Placing electrodes for respiration monitoring	70
8.4 Respiration display	71
8.5 Respiration setup	72
8.6 Alarm setup	73
9. PR	74
9.1 Overview	74
9.2 Display	74
9.3 Setting PR sound	74
9.4 Alarm setup	74
10. SpO₂	75
10.1 Overview	75
10.2 Safety information	75
10.3 Monitoring steps	77
10.4 Display	78
10.5 Setting SpO ₂	79
10.6 Measuring influencing factors	80
10.7 Alarm setup	80
10.8 Technical description	81
11. NIBP	82
11.1 Overview	82
11.2 Safety information	83
11.3 Measurement limits	84
11.4 Measurement procedure	85
11.5 NIBP display	87
11.6 Setting inflation pressure	87
11.7 NIBP reset	87
11.8 Clean and disinfection method of NIBP cuff	88
11.9 Alarm setup	88

12. TEMP	89
12.1 Overview	89
12.2 Safety information	89
12.3 Measurement steps	89
12.4 Measurement requirements	90
12.5 Temperature display	90
12.6 Setting temperature unit	91
12.7 Alarm setup	91
13. Review	92
13.1 Reviewing trend chart	92
13.2 Reviewing trend table	93
13.3 NIBP measurement review	94
14. Battery	95
14.1 Overview	95
14.2 Battery usage guide	96
14.3 Checking battery performance	97
14.4 Battery recycling	97
15. Caring and cleaning	98
15.1 Overview	98
15.2 Cleaning	98
15.3 Disinfection	99
16. Maintenance	100
16.1 Checking	100
16.2 Viewing software version information	101
16.3 Maintenance plan	101
16.4 ECG calibration	102
17. Accessories	103
18. Specifications	104
18.1 Safety specification	104
18.2 Hardware specifications	105
18.3 Functional specification	106
19. Alarm information	111
19.1 Physiological alarm	111
19.2 Technical alarm	113
20. Default parameter configuration	115
21. Common faults and maintenance	117
22. Manufacturer's declaration on EMC	118
22.1 Electromagnetic emissions	119
22.2 Recommended separation distances between portable and mobile RF communications equipment and BT-770	120
22.3 Electromagnetic immunity	121

Product Warranty 123

Figure 1-1: Front view	21
Figure 1-2: Side view	21
Figure 1-3: Rear view	22
Figure 1-4: Front view	23
Figure 1-5: Side view	24
Figure 1-6: Rear view	25
Figure 1-7: Standard display	27
Figure 3-1: "Settings" menu	35
Figure 4-1: "Patient" menu	42
Figure 4-2: "Quick Admit" menu	42
Figure 4-3: "Patient Info" menu	43
Figure 5-1: Standard display	47
Figure 5-2: Big ECG format	48
Figure 5-3: Big font format	48
Figure 5-4: ECG 7-Lead full screen format	49
Figure 7-1: 3-Lead placement method	63
Figure 7-2: 5-Lead placement method	64
Figure 7-3: ECG wave in standard display format	66
Figure 7-4: ECG parameter in standard display format	66
Figure 7-5: "ECG Setup" menu	67
Figure 8-1: 5-lead respiration electrode placement	70
Figure 8-2: Respiration wave	71
Figure 8-3: Respiration parameter display	71
Figure 8-4: "RESP setup" menu	72
Figure 9-1: PR parameter display	74
Figure 10-1: SpO ₂ parameter display	78
Figure 10-2: SpO ₂ wave	78
Figure 10-3: "SpO ₂ Setup" menu	79
Figure 11-1: NIBP parameter display	87
Figure 12-1: TEMP parameter display	90
Figure 13-1: Trend chart	92
Figure 13-2: "Trend" table	93
Figure 13-3: NIBP measurement review	94

0 Safety information

Before using BT-770 Patient monitor, read this entire manual and be fully understood the following safety information to prevent injury of patient and user.

Symbols Used

The following symbols identify all instructions that are important to safety. Failure to follow these instructions can lead to injury or damage to the patient monitor. When used in conjunction with the following words, the symbols indicate:

 WARNING	Can lead to serious injury or death.
 CAUTION	Can lead to minor injury or product/property damage

The following symbols are placed on product, label, packaging and this manual in order to stand for the information about:



Used to identify safety information.
Be well-known this information thoroughly before using BT-770.



Used to identify safety information.
Be well-known this information thoroughly before using BT-770

IPX1

Indicates the protection level against the ingress of liquid.
IPX1 is protection against some water drops falling vertically.
It correspond the device, patient monitor and accessory, temperature sensor

IPX2

Indicates the protection level against the ingress of liquid.
IPX2 is protection from some water drops when the device is tilted up to and including 15°.
It correspond the accessories for SpO2 and ECG.



Refer to operation manual. Read manual before placing the device.



Indicates DC power supply.



Indicates the device is in the battery operation mode.



Indicates nurse call interface.



Indicates network interface.

	Indicates USB interface.
	Indicates power adapter polarity.
	Indicates the production date.
	Indicates the manufacturer.
	Indicates the serial number of the device.
	Indicates the authorized representative in the European Community of manufacturer.
	Indicates a defibrillation-proof type BF applied part.
	Indicates a defibrillation-proof type CF applied part.
	Indicates CLASS II equipment.(Adapter)
	Indicates the date after which the medical device is not to be used.
	Indicates to keep the device dry.
	Indicates the medical device that can be broken or damaged if not handled carefully.
	Indicates to keep upright
	Indicates the maximum stacking limit.
	Indicates the temperature limitation for operation, transport and storage.
	Indicates the humidity limitation for operation, transport and storage.
	Indicates the range of atmospheric pressure to which the medical device can be safely exposed.



Indicates the device contains natural rubber latex.(Accessories)



Indicates the packing material is recyclable.



Indicates to not dispose the device together with unsorted municipal waste(for EU only). The solid bar symbol indicates that mains adapter is put on the market after 13 August 2005.

0.1 General precautions, warnings and cautions

- Examine the patient monitor and any accessories periodically to ensure that the cables, adapter cords and instruments do not have visible evidence of damage that may affect patient safety or performance. The recommended inspection interval is once per week or less. Do not use the patient monitor if there is any visible sign of damage.
- Only the DC power adapter supplied with the BT-770 is approved for use with the device.
- Do not attempt to service the BT-770 patient monitor. Only qualified service personnel by Bistos Co. Ltd. should attempt any needed internal servicing.
- Perform periodic safety testing to insure proper patient safety. This should include leakage current measurement and insulation testing. The recommended testing interval is once per year.
- If the hospital or healthcare institutions using this device fail to implement a satisfactory maintenance schedule, it will result in device failure and may endanger the patient's safety.
- Use the patient monitor under the conditions specified in this operation manual. Beyond the conditions, the patient monitor may not function properly and the measurement results may not accurate and may result in device failure or endangering the patient's safety.
- Do not operate the BT-770 patient monitor if it fails to pass the power on self-test procedure.
- During the operation, do not disconnect any cable.
- The BT-770 patient monitor is intended to be used by clinical professionals or trained doctors, nurses or laboratory assistant.
- Do not service and maintain or clean the device including accessories while in use with a patient.
- Using the device to one patient at a time.

WARNING

- Thoroughly read and understand the manual prior to use of the BT-770. Failure to do so could result in personal injury or equipment damage.
 - The device is intended for clinical patient monitoring, and only trained and qualified doctors and nurses should use the device.
 - The alarm volume, upper and lower alarm limits should be set according to the actual situation of the using environment. Do not just rely on audio alarm
-

system while monitoring the patient, because too low alarm volume or muted alarm may result in notice failure of alarm situation and endanger the patient's safety. Please pay close attention to the actual clinical status of the patient.

- Use only the power adapter supplied with monitor.
 - Position the monitor where it is easy to de-energize the monitor when needed.
 - Do not open the enclosure to avoid an electric shock. Any repair and upgrade of monitor should be done by service personnel trained and authorized by Bistos. Co., Ltd.
 - When handling packaging materials, abide by local laws and regulations or hospital waste disposal regulations. Keep the packaging materials away from children.
 - Do not use in the presence of flammable anesthetics to prevent explosion or fire.
 - Install the power lines and cables of accessories carefully to avoid patient entanglement or suffocation, cables tangled or electrical interference.
 - When the monitor is used together with electrosurgical devices, the user (a doctor or a nurse) should ensure the safety of the patient and instrument.
 - The physiological wave, physiological parameters and alarm information displayed on the monitor are only for the doctor's reference and should not be directly used as the basis for clinical treatment.
 - This is not a therapeutic device.
 - For patients with pacemakers, the cardio tachometer may count the pacemaker pulse in case of a cardiac arrest or arrhythmias. Never rely solely on the cardio tachometer alarm. Closely monitor the patients with pacemaker. For the inhibition of the device on pacemaker, refers to this manual.
 - Use of accessories other than those listed and approved for use with this product may result in increased emissions or decreased immunity.
 - Medical electrical equipment needs special precautions regarding EMC and needs to be installed and put into service according to the EMC information provided in this manual. In addition, portable and mobile RF communications equipment can affect medical electrical equipment.
 - The equipment shall not be used adjacent to other devices unless verification of normal operation in the configuration in which it is to be used can be achieved.
 - Keep matches, and all other sources of ignition, out of the room in which the patient monitor is located. Textiles, oils, and other combustibles are easily ignited and burn with great intensity in air enriched with oxygen. Personal
-

injury or equipment damage could occur.

- A fire and explosion hazard exists when performing cleaning or maintenance procedures in an oxygen-enriched environment.
 - The patient monitor has been validated with the accessories and options listed in this manual and found to comply with all relevant safety and performance requirements applicable to the device. It is therefore the responsibility of the person or organization who makes an unauthorized modification, or incorporates an unapproved attachment to the device.
 - An operator may only perform maintenance procedures specifically described in this manual.
 - Do not remove the covers of a BT-770 yourself to avoid damage to the equipment and unexpected electrical shock. Only qualified Bistos service engineer must repair or replace components.
-

 **CAUTION**

- Please install or carry the instrument properly to prevent damage due to falling, collision, strong vibration or other mechanical force.
 - Avoid instrument splashed by water.
 - Avoid high temperatures, the instrument should be used within a temperature range of 5 °C ~ 40 °C。
 - Avoid using instrument in the environment such as pressure is too high, poor ventilation, dusty, or contain salt, sulfur gas and chemical.
 - Before using the monitor, check the monitor and accessories if there is damage that may affect patient safety. If there is obvious damage or aging, replace the parts before use. The replacement should be made with same parts of original parts.
 - Before powering on the device, make sure that the power used by the device complies with the supply voltage and frequency requirements on the equipment label or in the Operator's Manual.
 - Equipment should be tested at least once a year, the test should be done and recorded by trained, have security testing knowledge and experienced personnel. If there are any problems in the tests, they must be repaired.
 - When the instrument and accessories are about to exceed the useful life (expected service life: 5 years), it must be treated in accordance with relevant local laws and regulations or the hospital's rules and regulations.
 - Do not connect to other equipment or network which not specified in the
-

instruction for use, in risk of external high voltage.

- Do not connect any equipment or accessories that are not approved by the manufacturer or according to IEC 60601-1 to the monitor. The operation or use of non-approved equipment or accessories with the monitor is not tested or supported, and monitor operation and safety are not guaranteed in such a case.
 - Any non-medical equipment (such as the external printer) is not allowed to be used within the patient vicinity (1.5m/6ft.).
 - Parts and accessories used must meet the requirements of the applicable safety standards, and/or the system configuration must meet the requirements of the medical electrical systems standard.
 - Ensure that the conductive parts of electrodes and associated connectors, including neutral electrodes, do not come in contact with earth or any other conducting objects.
 - Protection of ME EQUIPMENT against effects of discharge of a cardiac defibrillator depends on use of proper cables.
-

0.2 Shock hazards

 WARNING

- Unplug the monitor from its power source prior to cleaning or maintenance to prevent personal injury or equipment damage.
 - Some chemical cleaning agents may be conductive and leave a residue that may permit a build-up of conductive dust or dirt. Do not allow cleaning agents to contact electrical components and do not spray cleaning solutions onto any of these surfaces. Personal injury or equipment damage could occur.
 - Do not expose the unit to excessive moisture that would allow for liquid pooling. Personal injury or equipment damage could occur.
 - Do not touch the patient and signal input/output parts simultaneously
 - Due to the risk of electrical shock hazard, only qualified personnel with appropriate service documentation should service the monitor.
-

0.3 Battery warnings

WARNING

- Improper operation may cause the internal lithium ion battery to be hot, ignited or exploded, and it may lead to the decrease of the battery capacity. It is necessary to read the operation manual carefully and pay more attention to warning message.
 - Do not open the battery compartment. Only the qualified service personnel authorized by the manufacturer can open the battery compartment and replace the battery, and batteries of same model and specification should be replaced.
 - Be careful when connecting the battery with polarity.
 - Do not use the battery near fire or environmental temperature exceeds 60 °C . Do not heat or splash the battery or throw it into fire or water.
 - Do not destroy the battery. Do not pierce battery with a sharp object such as a needle. Do not hit with a hammer, step on or throw or drop the battery. Do not disassemble or modify the battery. The battery can heat, smoke, deformation or burning.
 - When leakage or foul smell is found, stop using the battery immediately. If your skin or cloth comes into contact with leaked liquid, cleanse it with clean water at once. If the leaked liquid splashes into your eyes, do not wipe them. Irrigate them with clean water first and go to see a doctor immediately.
 - Properly dispose of or recycle the depleted battery according to local regulations.
-

0.4 General precautions on environment

Do not keep or operate the equipment under the environment listed below.

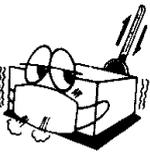
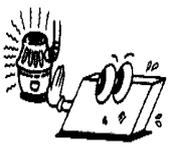
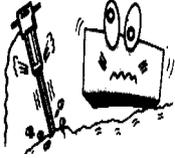
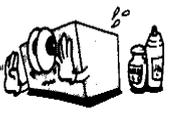
	<p>Avoid placing in an area exposed to moisture. Do not touch the equipment with wet hand.</p>		<p>Avoid exposure to direct sunlight</p>
	<p>Avoid placing in an area where high variation of temperature exists. Operating temperature ranges from 5°C ~ 40°C. Operating humidity ranges from 30% ~ 85 %.</p>		<p>Avoid in the vicinity of electric heater.</p>
	<p>Avoid placing in an area where there is an excessive humidity rise or ventilation problem.</p>		<p>Avoid placing in an area where there is an excessive shock or vibration.</p>
	<p>Avoid placing in an area where chemicals are stored or where there is in danger of gas leakage.</p>		<p>Avoid dust and especially metal material enter into the equipment</p>
	<p>Do not disjoint or disassemble the device. Bistos Co., Ltd. does not have liability of it.</p>		<p>Power off when the equipment is not fully ready to operate. Otherwise, the equipment could be damaged.</p>

1 System basics

1.1 Intended use

The BT-770 Patient Monitors acquire the physiological signals such as ECG, respiratory rate, non-invasive blood pressure (NIBP), blood oxygen saturation (SpO₂) and temperature. The signals are converted into digital data and processed, examines the data for alarm conditions and display them. The monitor also provides an operation control panel for users. The patient monitor intend to use in hospital clinical area such as intensive care units, cardiac care units, operating room, emergency department, to provide additional information to the medical and nursing staff about the physiological condition of the adult. The BT-770 patient monitors are intended to be used only under regular supervision of clinical personnel. It is suitable for adult and pediatric. The intended locations of use are hospitals and clinics.

1) Intended patient population

- Pediatrics (30 days < and <18 years) and adult (>18 years adults)

2) Intended user profile

- Doctor, physicians or nursing staff who is qualified personnel
- Basic experiences or knowledge on medical field, especially on patient monitoring
- Trained or requested to read IFU before use

3) Environment of use

- Hospital and clinic
- Requirements: Stable power source

4) Scope of application

This monitor is suitable for bedside monitoring of adults and pediatric. This monitor enables ECG, respiration (RESP), pulse rate (PR), blood oxygen saturation (SpO₂), noninvasive blood pressure (NIBP) and temperature (TEMP) monitoring. It is equipped with a replaceable built-in battery to provide convenience for the patient movement in hospital.

5) Indications and contraindications

Blood oxygen saturation (SpO₂)

Indication:

- Monitoring effectiveness of oxygen therapy
 - A reading is needed to facilitate the completion of an early warning score to inform clinical assessment
 - Sedation or anesthesia
 - Transport of patients who are unwell and require oxygenation assessment
 - Haemodynamic instability (e.g. cardiac failure or Myocardial Infarction)
 - Respiratory illness e.g. asthma, chronic obstructive pulmonary disease
 - Monitoring during administration of respiratory depressant drugs, e.g. opiate epidural or patient-controlled analgesia.
 - Assessing oxygen saturation during physical activity e.g. in pulmonary rehabilitation
-

Contraindications

- Pulse oximetry does not give an indication of haemoglobin so if the patient is profoundly anaemic then their oxygen saturation may be normal but they may still be hypoxic
-

Source: NHS. "Clinical Procedure_ Procedure for Pulse Oximetry/SPO2". Wirral Community NHS Trust. Sep, 2013

Non-invasive blood pressure (NIBP)

Indication:

- To determine a patient's blood pressure
 - Screen for hypertension
 - Following the effect of anti-hypertensive treatments in a patient to optimize their management
 - Assessing a person's suitability for a spot or certain occupations
 - Estimation of cardiovascular risk
 - Determining for the risk of various medical procedure
 - Figuring out whether a patient is clinically deteriorating or is at risk.
-

Contraindications

- Oscillometric blood pressure devices may not be accurate in patients with weak or thready pulse
 - In patients with heart beats below 50 beats/minutes, even if the rhythm is regular, some of the semi-automatic devices are unable to reduce their deflation rate sufficiently so that too rapid a falling in cuff pressure results in underestimation of systolic blood pressure and overestimation of diastolic blood pressure.
 - Do not apply to limb with AV fistula, significant injury or burn, or lymph node removal post mastectomy.
-

Source: [1] NHS. "Clinical Procedure_ Procedure for Blood Pressure Monitoring". Wirral Community NHS Trust. Dec, 2013

[2] Clinical Quality & Patient Safety Unit, QAS. *Clinical Practice Procedures: Assessment/Non-invasive blood pressure*. Queensland Government, 2016. <https://www.ambulance.qld.gov.au/clinical.html>

Electrocardiography (ECG)

Indication:

- The electrocardiogram (ECG) has proven to be among the most useful diagnostic test in clinical medicine. It is routinely used in the evaluation of patients to detect myocardial injury, ischemia and the presence of prior infarction, in the assessment of patients with electrolyte abnormalities, drug toxicities and implanted defibrillators and pacemakers.
- In addition to its usefulness in the evaluation of ischemic coronary disease, the ECG, in conjunction with ambulatory ECG monitoring, is of particular use in the diagnosis of disorders of the cardiac rhythm and in the evaluation of syncope. Other common uses of the ECG include the assessment of metabolic disorders and side effects of pharmacotherapy, as the evaluation of primary and secondary cardiomyopathic processes, among others.

Contraindications

- No absolute contraindications to performing an ECG exist, other than patient refusal. Some patients may have allergies or, more commonly, sensitivities to the adhesive used to affix the leads; in these cases, hypoallergenic alternatives are available from various manufacturers.

Source: Tarek, A. "Electrocardiography", <Medscape>, Apr 17, 2017

Temperature (TEMP)

Indication:

- To obtain the baseline temperature to enable comparisons to be made with future recordings
- To enable close observation in resolving hypothermia/hyperthermia
- To observe and monitor patients for changes indicating an infection
- To monitor the effect of treatment for antimicrobial therapy for infection
- Using before and during a blood transfusion to monitor for signs of a reaction

Contraindications

- No known contraindications
-

1.2 Operating principle

Refer to the chapters for every physiological parameter from chapter 7 to chapter 12.

1.3 System configurations

Basic configuration of BT-770

- Main body with 12 inch touch screen and built-in lithium-ion battery
- ECG cable and electrode
- Adult SpO2 probe and extension cable
- Non-invasive blood pressure cuff
- Temperature probe
- AC/DC adapter

Options of BT-770

- External plug-in printer

Picture	Name	Description	Qty
	ECG cable and lead wire (standard)	Measures ECG	1ea
	ECG electrode (standard)	Electrode for ECG measurement	1ea
	Adult SpO2 sensor (standard)	SpO2 sensor for adult	1ea
	SpO ₂ extension cord (Standard)	Cord to connect the SpO2 sensor and main body	1ea
	Adult NIBP cuff (standard)	Measures NIBP for adult	1ea
	NIBP extension tube (standard)	Tube to connect the NIBP cuff and main body	1ea
	Temperature sensor (Standard)	Measures the body temperature	1ea
	Adapter (Standard)	For power supply	1ea

1.4 Product outlook

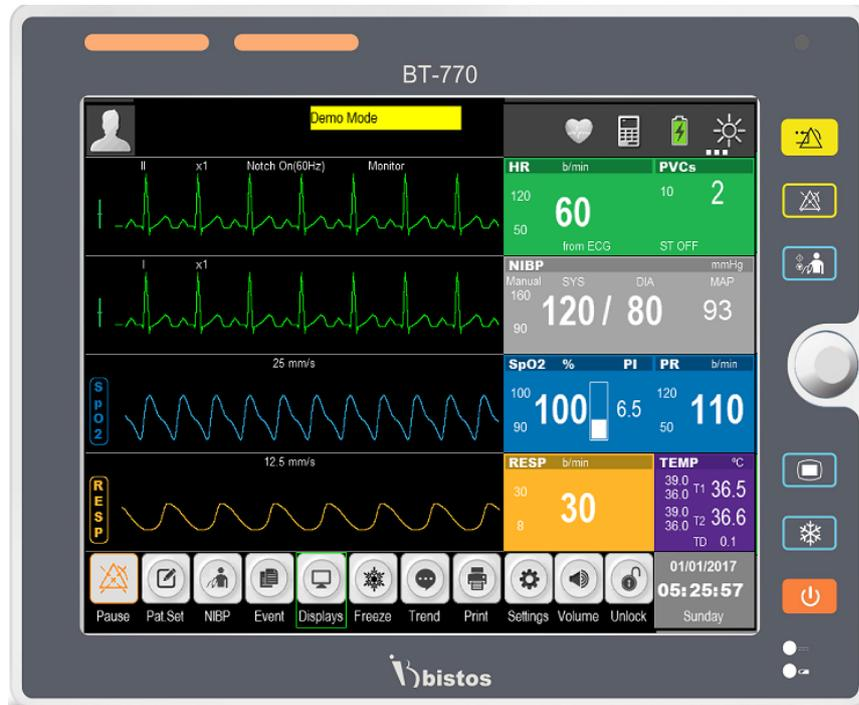

Figure1-1: Front view



Figure1-2 : Side view



Figure1-3 : Rear view

1.5 Description of monitor

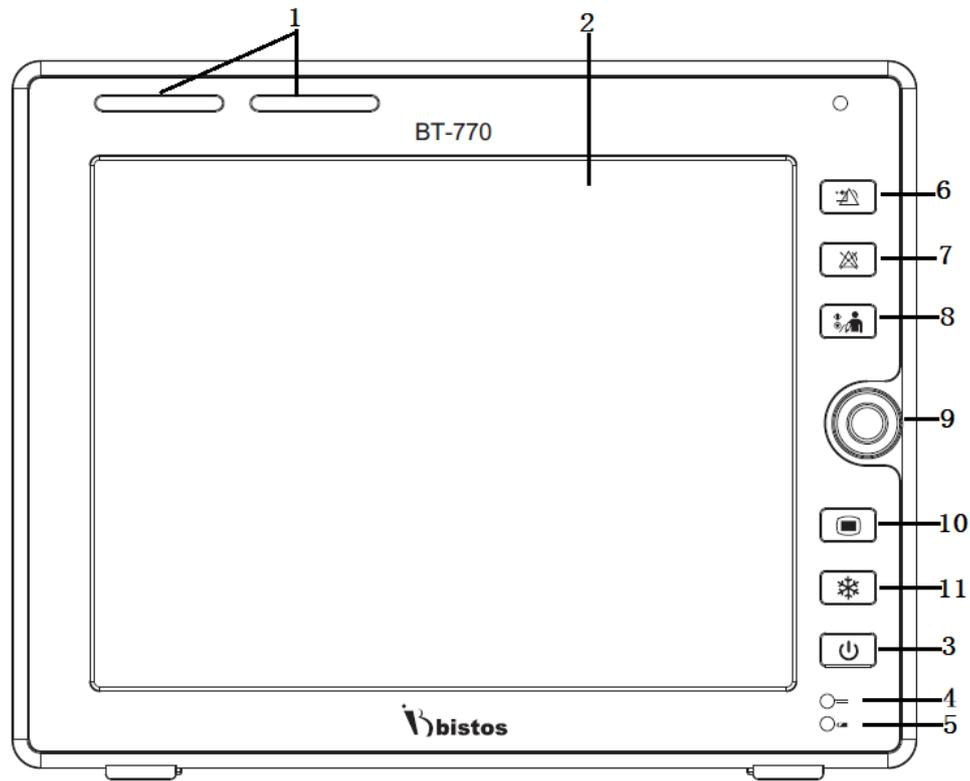

Figure1-4: Front view

	Name	Description
1	Alarm indicator	Indicates the priority of physiological alarm and technical alarms in different colors and flashing frequencies. <ul style="list-style-type: none"> - High priority: Red, fast flashing (1.4 - 2.8 Hz) - Medium priority: Yellow, slow flashing (0.4 - 0.8 Hz) - Low priority: Yellow, constant on
2	Display area	Display the waveform and measured value
3	 [Power]	<ul style="list-style-type: none"> - Power On: Press down the key more than 2 seconds. - Power Off: Press down the keys more than 2 seconds and the system will display the alarm message "The system will shut down 3 seconds".
4	Battery indicator	<ul style="list-style-type: none"> - On: The battery is being charged or has been fully charged. - Off: The battery has not been installed. - Flashing: The monitor is being powered by the battery.
5	DC power indicator	Turned on when the monitor is being powered by the adapter.
6	 [Alarm reset]	To reset the alarm condition.

7	 [Alarm pause]	To pause the alarm sound. Alarm pause time can be set as 1 , 2, 3, 4, 5, 10, 15 minutes, and permanent. Default setting is 2 minutes.
8	 [NIBP start/stop]	Start and stop the non-invasive blood pressure measurement.
9	Control knob	Rotate: move the cursor. Press: select the menu or execute a command.
10	 [Setting]	Enter to the setting mode. Press again to close the setting mode.
11	 [Freeze]	Freeze/unfreeze the waveform.

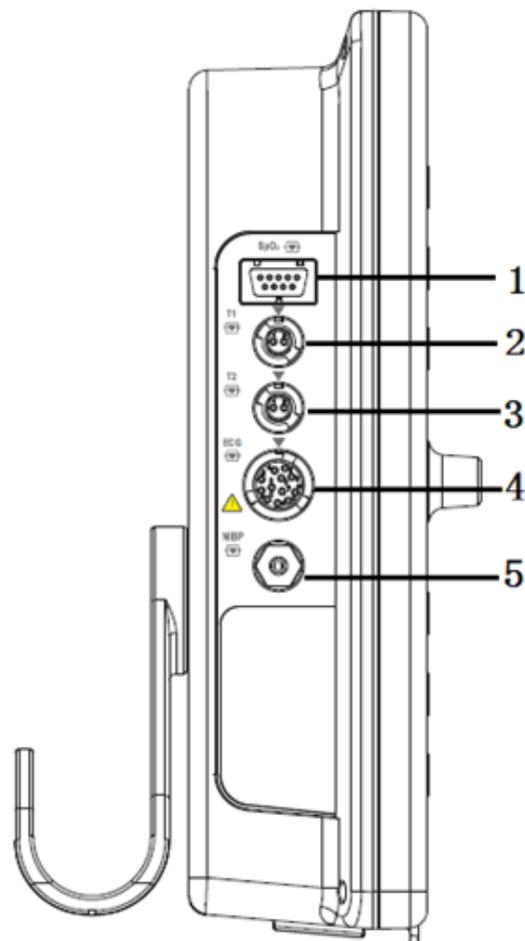

Figure1-5: Side view

	Name	Description
1	SpO2	SpO2 cable interface
2	T1	Temperature probe interface
3	T2	Temperature probe interface
4	ECG	ECG cable interface
5	NIBP	NIBP cuff interface

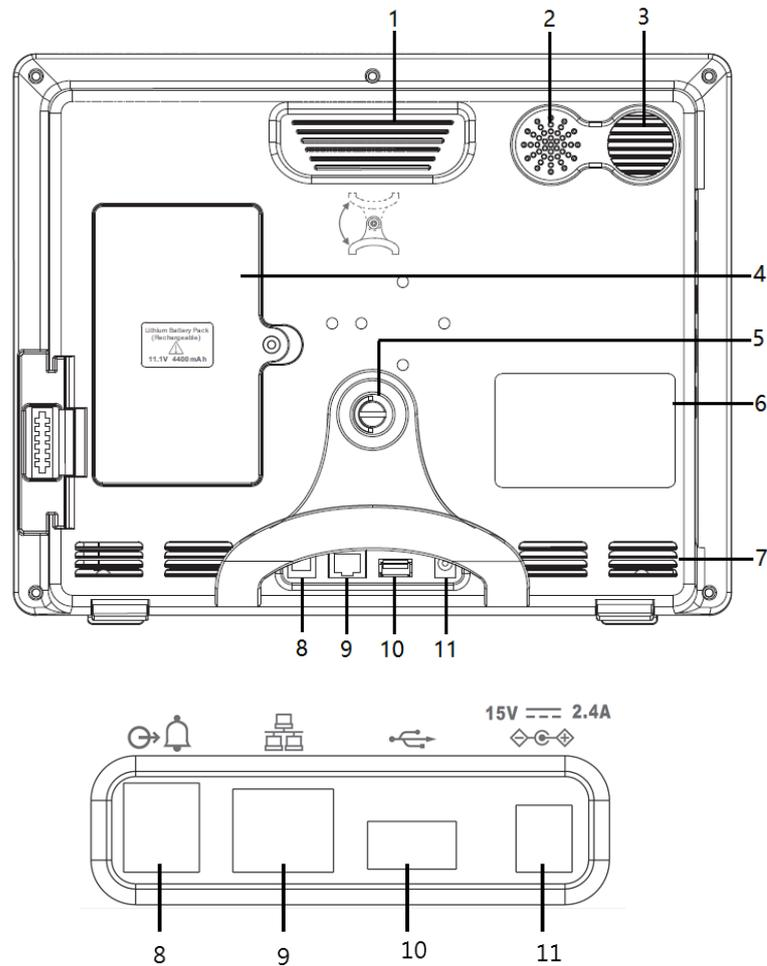

Figure1-6: Rear view

	Name	Description
1	Handle	Handle for main body transport
2	Speaker holes	For alarm and synchronizing sound
3	Air outlet	Heat dissipation
4	Battery cover	Battery compartment cover

5	Bracket	To wall mount the monitor
6	ID label	Identify the monitor information
7	Air intake	For ventilation
8	Auxiliary output interface	Nurse call
9	Network port	For CMS
10	USB port	For trend or software upgrade
11	Power adapter	15V, 2.4A adapter

1.6 Understanding the display

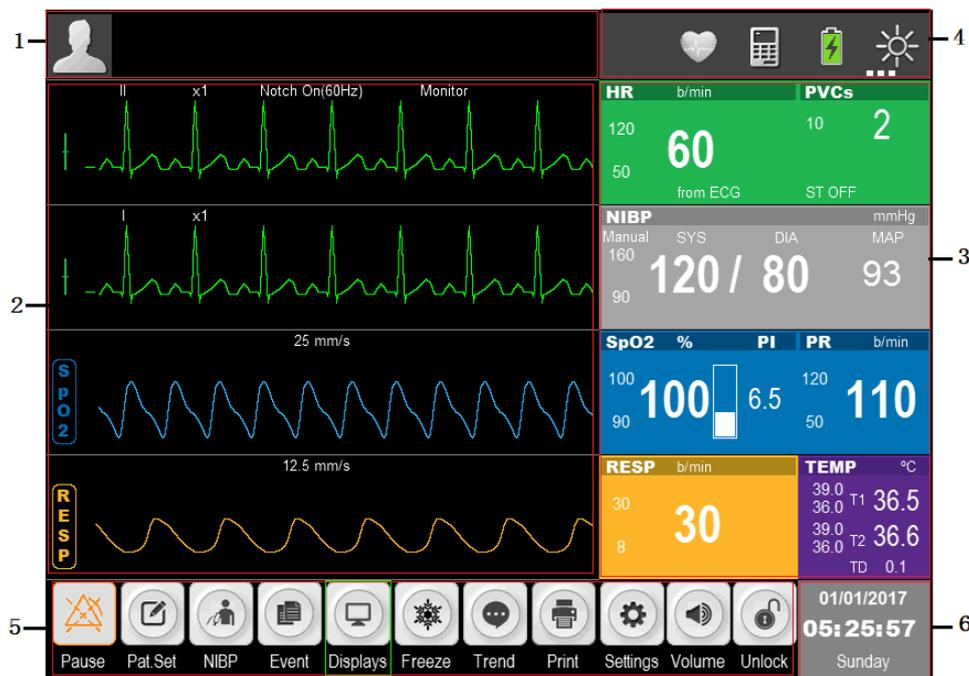

Figure 1-7: Standard display

	Name	Description
1	Information area	Include patient information, alarm status icon, physiological and technical alarms. In DEOM mode, it displays “DEMO”.
2	Waveform area	Mainly display the waves of physiological parameters with name of the parameter on the left side.
3	Parameter area	Show the corresponding parameter measured value and current upper and lower alarm limits of each parameter module. The parameters are shown in fixed position, that is, from top to bottom and from left to right: <ul style="list-style-type: none"> - ECG - NIBP - SpO₂ and PR - TEMP - RESP
4	Information Tip Area	Display the network status, battery status, automatic identification screen brightness icon.
5	Hot key icons	Shows the hotkeys, which are frequently used for some common operations.
6	Date and Time area	Display the current date and time.

1.7 Smart Hotkeys

Smart hotkeys are graphic hotkeys displayed at the bottom of the main screen of the monitor, and enable the user to use specific features conveniently.

Key	Name	Description
	[Pause]	Alarm pause
	[Pat. Set]	Patient information setting
	[NIBP]	NIBP measurement start and stop
	[Event]	Manual event mark
	[Displays]	Change the display format
	[Freeze]	Freeze the waveform
	[Trend]	Trend display
	[Print]	Print key
	[Settings]	Setup menu
	[Volume]	Volume setup key
	[Unlock]	Touch screen lock key

1.8 Essential performance

This device Multi-parameter Patient Monitor provides various patient vital signs such as pulse rate, ECG, respiration, blood oxygen saturation, blood pressure and temperature by placing or inserting the various sensors to the appropriate site of patient. The device is composed with display, control circuit and panel, and input part for various sensors. It detects ECG, SpO2, NIBP, etc. using ECG cable and specific probes and sensors. The detected analog signal amplifies and converted to digital. This concerted data feed to the CPU and converted to the display format as number and waveform. This device is incorporated with alarm system. The alarm generated when the detected signal range is beyond the user set alarm limits.

2 Preparing for operations

2.1 Installation

To ensure normal working of the monitor, read this chapter before use, and install as required.

⚠ WARNING

- All analog and digital devices connected to the monitor must be certified by IEC standards (e.g. IEC 60950 Data processing equipment standard and IEC 60601-1 Medical equipment standard). Furthermore, all configurations shall comply with valid version of IEC 60601-1 standard. The personnel connecting additional devices to the input / output signal ports are responsible for the compliance with IEC 60601-1 standard. If there is any question, please contact Bistos.
 - If the patient cable interface and network interface are connected with multiple devices, the total electric leakage current cannot exceed the allowable value.
 - The copyright of monitor software belongs to our company. Without permission, any organization or individual shall not interpolate, copy or exchange by any means or form.
 - When the monitor is combined with other devices, it must comply with IEC 60601-1:2005 + A1:2012, and should not be connected with multiple socket outlet or extension cord.
 - Do not connect the device on other equipment or network, to which a signal input/output part may be connected.
-

Prior to installation, the operator must ensure that the following space, power, environmental requirements are met.

2.1.1 Unpack and check

BT-770 patient monitor was inspected rigorously at the factory before delivery, in order to avoid being hit when transported, carried out careful packaging. Before unpacking, carefully inspect the package. If any damage, please immediately contact the Bistos. Unpack in the correct way, carefully remove the monitor and accessories from the box and check with the packing list. Check if there is any mechanical damage, the all listed are completely packed. If you have questions, please contact the marketing department of Bistos or agency.

Please keep the packing box and materials for use in future transporting or storage.

2.1.2 Placement requirements

Equipment installation must meet:

- The left and right side of the monitor should have space more than 100 cm from the wall
- Back on the monitor should have space more than 50 cm.
- Ensure that the operating floor and the monitor have enough space for connecting the accessory wires.

2.1.3 Power requirements

- DC power supply adapter

Input: A.C. 100 V - 240 V, 50/60 Hz

Output: D.C. 15 V, 2.5 A

- Built-in rechargeable lithium-ion battery: D.C. 11.1 V, 4400 mAh

2.1.4 Environmental requirements

The storage, transport and use of the monitor must meet the following environmental requirements.

Operating environment	Ambient temperature	5°C ~ 40 °C
	Relative humidity	30 % ~ 85 % (Non-condensing)
	Atmospheric pressure	700 ~ 1060 mbar (hPa)
Transportation	Prevent severe shock, vibration, rain and snow splashing during transport.	
Storage	The packaged monitor should be stored in well-ventilated room with ambient temperature -20 °C ~ 60°C, relative humidity 0 ~ 95 % (Non-condensing), atmospheric pressure 700 ~ 1060 mbar(hPa), and without corrosive gases.	

The operating environment of the monitor should avoid noise, vibration, dust, corrosive or flammable and explosive materials. In order to allow air flowing smoothly and achieve good heat dissipation, at least 2 inches (5cm) clearance should be kept around the device.

When the device is moved from one environment to another, the device may have condensation due to the differences in temperature or humidity. In this case, wait until the condensation disappears before using the device.

WARNING

- Ensure that the monitor is used under specified environment. Fail to do this, the technical specifications declared in this manual may not be met and it may result in damage to equipment and other unforeseen consequences.
-

2.2 Connecting to power

**WARNING**

- Do not try to open the monitor when the power is connecting.
 - During the operation, do not disconnect any cable.
-

Connect to power adapter in the following steps:

- Make sure that the AC power supply meets the following specifications: a.c.100V-240V, 50/60Hz.
- Use the power adapter provided with the monitor. Plug the power adapter into the power connector of the monitor, and plug the other end of the power adapter into the mains (low voltage power supply network facilities) power outlet with protective earth.

3 Basic operations

3.1 Turn on

3.1.1 Check the monitor

- Before turn on the monitor, check whether there is mechanical damage to the monitor, and whether the external cables and accessories are connected correctly.
- Plug the power adapter into the AC power outlet. If using battery power, make sure the battery is fully charged.
- Check all the functions required for patient monitoring to make sure that the monitor operates properly.

 **WARNING**

- If the monitor is damaged, or fails to work normally, do not use it for patient monitoring. Please contact the maintenance personnel or Bistos immediately.
-

3.1.2 Start the monitor

If finish to check the monitor, it is ready to start the monitor.

Press the  [Power] key, the yellow warning lights flash once and the system enter the program reading interface; finally the system makes a “tick” sound, the boot screen disappears, and the system enters the main interface.

- If any fatal error occurs during self-test, the system will alarm. If this case persists, please stop to using the monitor and contact the maintenance personnel or Bistos.
- Check all available monitor functions to ensure that the monitor operate properly.
- If the monitor equipped with a battery, charge the battery after each use to ensure sufficient power.
- After unpacking, when use the monitor first time, the monitor should be powered with adapter.

3.1.3 Connect the sensors

Connect the required sensor to the monitor and the monitoring site of patient.

3.1.4 Start monitoring

Start monitoring in the following steps:

- Check if the patient cable and the sensor are connected properly.
- Check if the settings of the monitor are corrects, such as patient type.
- For the details of parameter measurement or monitoring, see the appropriate section.
- The operator can operate according to their own habits, standing in front, left or right of the monitor, easy to observe and operate the monitor.

3.2 Turn off

Turn off the monitor in the following steps

- Disconnect the cables and sensors connected to the patient.
- Press and hold the  [Power] key for 2 seconds to pop up the 3 seconds countdown window, and the monitor turns off in 3 seconds.

CAUTION

- If the monitor is not turned off properly, you can simply disconnect the power to shutdown forcibly. But the forced shutdown may cause data loss, and it is not recommended.
-

3.3 Basic operations

3.3.1 Using the control knob

Control knob can be used to perform the following operations:

- Rotate: Rotate control knob clockwise or counter clockwise to move the cursor.
- Press: Press control knob to perform an action, such as access to a menu or execute a command.

Control knob is the main control means. On the interface or the menu, the green highlighted box that moves with the knob turning is called the cursor. By turning the control knob, you can position the cursor in order to perform the desired operation.

3.3.2 Using keys

The monitor has three types of keys:

- Soft keys: Within the display these keys allow quick access to certain menus or performing certain actions, including:
 - Parameter hotkeys: Select a parameter area and enter the appropriate parameter setup menu, including drug calculation and time setup.
 - Wave hotkeys: Select a wave area and enter the appropriate parameter setup.
 - Smart hotkeys: The shortcut keys that the user can operate quickly are displayed at bottom of the screen. Refer to '1.7 Smart Hotkeys'.
- Hard keys: The physical keys on the monitor, such as the [Alarm pause] key on the front panel.
- Popup keys: Menu keys relevant to the tasks that automatically appear on the monitor screen when need, such as, the confirmation key popped up when you need to confirm the change.

3.3.3 Using the touch screen

Click on the touch screen to quickly and easily perform specific operation.

3.3.4 Using soft keyboard

If you choose a menu which needs to enter characters, the system will display the soft keyboard on the screen. If you finish entering, press [Enter] key to confirm that you have finished entering and close the soft keyboard.

3.3.5 Using menu

Select the  [Settings] smart key on the monitor or press the  [Setting] key on the monitor panel to open the “Settings” mode as shown below. You can set-up the monitor.

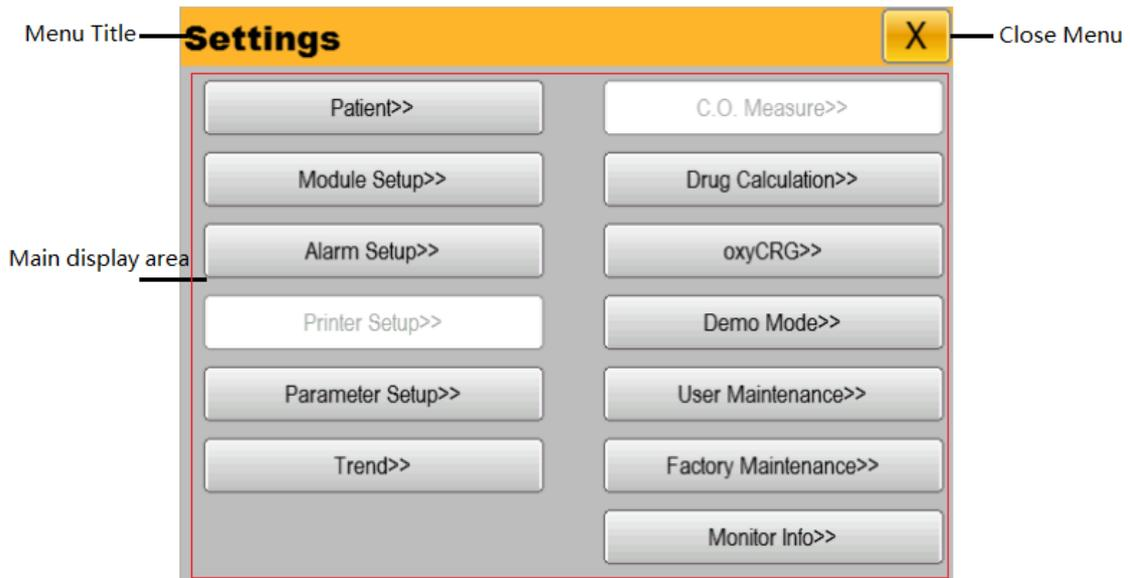

Figure 3-1: "Setting" menu

The style of other menus is basically similar to the “Settings”, and generally consists of the following components:

- Menu title: A title of the current menu.
- Close menu: Close the current menu. Exit the current menu or close the current menu and return to the previous menu.
- Main display area: Display options, buttons or prompt messages. The symbol ">>" indicates that selecting this option can enter the corresponding submenu.
- Confirmation key area: Some menus contain a confirmation key area to confirm the menu operations, including confirmation and cancel key.

3.4 Operation mode

The monitor has 2 operating modes, of which the demo mode is protected by a password.

1. Monitoring mode (operating mode)

This is the daily operating mode of patient monitoring; you can change some settings in accordance with the patients, such as alarm limits. However, when the patient is discharged, the monitor will restore these settings to default according to pre-set configuration.

2. Demo mode

This mode is protected by a password for demonstration purpose only.

- Enter the demo mode:
 - Select  [Settings] Smart Hotkey or press  [Setting] key on the monitor panel → "Settings";
 - Select "Demo Mode>>" → enter the password and confirm, and the monitor enters the demo mode.
- Exit demo mode:
 - Select  [Settings] Smart Hotkey or press  [Setting] key on the monitor panel → "Settings";
 - Select "Exit Demo >>" and the monitor exits the demo mode.

WARNING

- The demo mode is mainly used to show the monitor's performance and for user training. In actual clinical use, the demo function is prohibited in order to avoid mistaking the displayed waves and parameters as those of the patient, thus affecting patient monitoring, and delaying diagnosis and treatment.
-

3.5 Measurement setup

This section only describes the general settings of measuring wave in monitor mode; for other specific settings of each parameter, please refer to the appropriate section.

Select the wave area of a parameter to enter the appropriate setup menu. The setup menu defines the specific wave setup of the parameter, such as wave gain and wave speed. You may set the waves of different parameters as needed.

3.6 Freezing waves

In the patient monitoring process, you can freeze the wave on the screen, review and carefully observe the patient's condition during this time. Freeze / unfreeze the wave as follows:

Select  **【Freeze】** hotkey or press the  **【Freeze】** key on the monitor panel to freeze the displayed wave of the monitor.

Select  **【Freeze】** hotkey or press the  **【Freeze】** key on the monitor panel again to release the freezing state.

3.7 Other common setup

The common setup of the monitor is the general setup that defines how the monitor works, for example: alarm volume setting. They may affect the setup of multiple measurements or display interfaces.

3.7.1 Defining the monitor

When install the monitor or change the usage occasion, the monitor should be defined as follows:

- Select  **【Settings】**Smart Hotkey or press  **【Setting】** key on the monitor panel → "Settings".
- Select "User Maintenance >>" → enter the password and confirm → "User Maintenance" menu.
 - Select "Device Name": Enter device name through the soft keyboard on the screen.
 - Select "Department": Enter the sector and department using the device through the soft keyboard on the screen.
 - Select "Bed Number": Enter the bed number through the soft keyboard on the screen.

3.7.2 Language setup

Set the monitor language in the following steps:

- Select  [Settings] Smart Hotkey or press  [Setting] key on the monitor panel → "Settings".
- Select "User Maintenance >>" → enter the password and confirm → "User Maintenance" menu.
- Select "Language", and select the option as needed:
 - "English": The interface language of the monitor is English.
 - "Türkçe": The interface language of the monitor is Turkish.
 - "Español": The interface language of the monitor is Spanish.
 - "Français": The interface language of the monitor is French.

3.7.3 Date and time

Set the monitor time in the following steps:

- Select  [Settings] Smart Hotkey or press  [Setting] key on the monitor panel → "Settings";
- Select "User Maintenance >>" → enter the password and confirm → "User Maintenance" menu.
- Select "Time Setup >>" → enter "Time Setup>>" menu.
- Or you can enter the "Time Setup" directly by touching the time display area on the display.
- "Date (YYYY-MM-DD)": Set the year, month, and day.
- "Time (24H)": Set the hour, minute and second.
- Select "Date Format", and set the date format in accordance with custom
 - "YYYY-MM-DD": Year- Month-Day.
 - "MM-DD-YYYY": Month -Day-Year.
 - "DD-MM-YYYY": Day-Month-Year.
- "Time Format", set the time format is 24H.

3.7.4 Volume control

1. Alarm Volume

- Select  **[Volume]** smart hotkey → “Volume Setup” menu.
- Select “Alarm Volume”: Set alarm volume from 1 to 9.

2. QRS Volume

- Select  **[Volume]** smart hotkey → “Volume Setup” menu.
- Select “QRS Volume”: Set QRS volume from 0 to 9. 0 means off.

3. Pulse Volume

- Select  **[Volume]** smart hotkey → “Volume Setup” menu.
- Select “Pulse Volume”: Set pulse volume from 0 to 9. 0 means off.

4. Touch Volume

- Select  **[Volume]** smart hotkey → “Volume Setup” menu.
- Select “Touch Volume”: Set touch volume from 0 to 9. 0 means off.

5. Key Volume

- Select  **[Volume]** smart hotkey → “Volume Setup” menu.
- Select “Key Volume”: Set key volume from 0 to 9. 0 means off.

3.7.5 Setting parameter unit

You can select a preferred unit through the following operations

- Select  **[Settings]** Smart Hotkey or press  **[Setting]** key on the monitor panel → “Settings”.
- Select “User Maintenance >>” → enter the password and confirm → “User Maintenance” menu.
- Select “Unit Setup >>” → “Unit Setup” menu.
 - Select “Height Unit”, and select the unit “cm” / “inch” as needed.
 - Select “Weight Unit”, and select the unit “kg” / “lb” as needed.

- “ST Unit” fixed as “mV”, is not optional.
- Select “Pressure Unit”, and select the unit “mmHg” / “kPa” as needed.
- Select “TEMP Unit”, and select the unit “°C” / “°F” as needed.

4 Patient information management

Connect the patient to the monitor, and the monitor will display and store the physiological data of the patient, so the patient can be monitored without admitting the patient. However, admitting the patient correctly is very important.

If the monitor has admitted the patient, it is recommended to operate the monitor to discharge the current patient before connecting to (not admitted) the next patient. Otherwise, the data of the previous patient will be stored in the data of the current patient.

WARNING

- Whether the patient is admitted or not, the system will give a default value to “Patient Type” and “Pace Maker”, “Patient Type” default “Adult”, “Pace Maker” default “No”, and the user must confirm that the default value is appropriate for the patient being monitored.
 - For patients with pacemakers, “Pace Maker” must be set to “Yes”. Otherwise, the pacing pulse will be treated as normal QRS wave group, and the system is unable to detect the alarm status of “ECG Signal weak”.
 - For patients without a pacemaker, “Pace Maker” must be set to “No”. Otherwise, the system is unable to detect the arrhythmias (including PVCs count) related to ventricular premature beats, and fails to perform ST segment analysis.
-

4.1 Patient setup menu

You can manage the patient through the “Patient” menu. To enter “Patient” menu, operate as follows:

Select  [Settings] Smart Hotkey or press  [Setting] key on the monitor panel → “Settings” → “Patient >>” → “Patient” menu;

Or

Select  [Pat. Set] Smart Hotkey to enter “Patient” menu, as shown in Fig. 4-1.

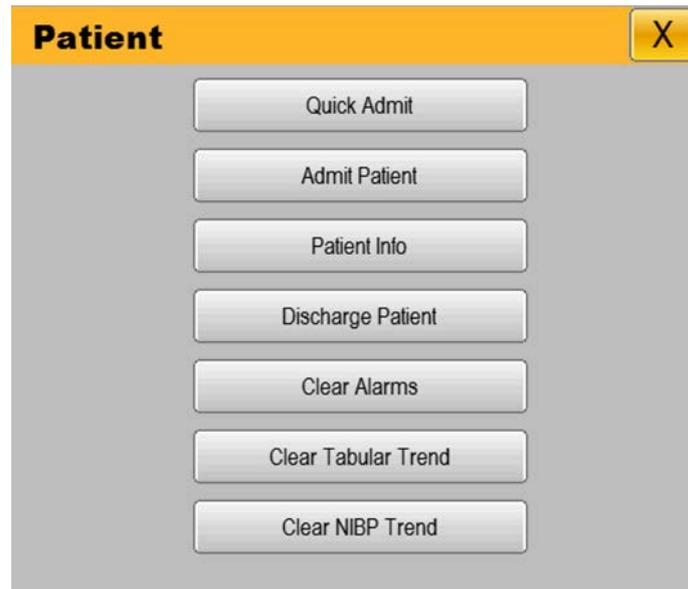

Figure 4-1 "Patient" menu

4.2 Admitting a patient

Admit a patient as follows:

In "Patient" menu, select "Quick Admit" → "Warning" message → "OK" → "Quick Admit" menu, as shown in Figure 4-2.

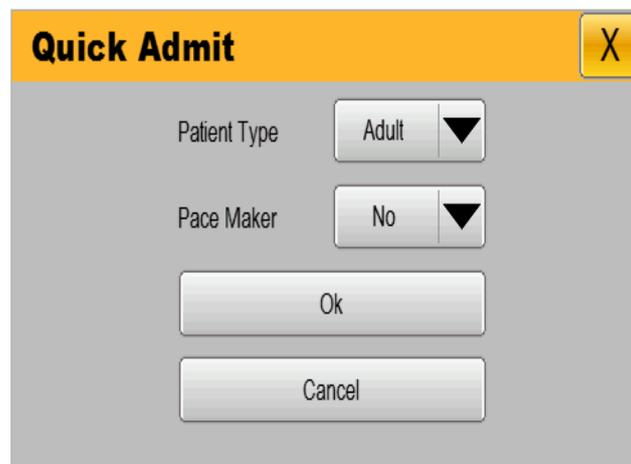

Figure 4-2 "Quick Admit" menu

- Select "Patient Type", and set the patient category as needed: "Adult" and "Pediatric".
- Select "Pace Maker", and set whether the patient wears a pacemaker according to the patient condition: "Yes" or "No".
- After setting, select "OK" to save the current setup or select "Cancel" and do not save the current setup.

4.3 Patient information

To edit patient information, operate as follows:

In the “Patient” menu, select “Patient Info”. The “Patient Info” menu as shown in Figure 4-3 will be displayed.

The screenshot shows a 'Patient Info' dialog box with a yellow title bar. The form contains the following fields and controls:

- Last Name: Text input field
- First Name: Text input field
- Patient ID: Text input field
- Case Number: Text input field
- Gender: Dropdown menu
- Height(cm): Text input field with a label '= (inch)' to its right
- Patient Type: Dropdown menu with 'Adult' selected
- Weight(kg): Text input field with a label '= (lb)' to its right
- Pace Maker: Dropdown menu with 'No' selected
- Blood Type: Dropdown menu
- Admission Date MM-DD-YYYY: Three text input fields
- Birthday MM-DD-YYYY: Three text input fields
- Ok: Button
- Cancel: Button

Figure 4-3. “Patient Info” menu

1. Select “Last Name”, and enter patient’s surname through the soft keyboard (Letters: not more than 20 characters) .
2. Select “First Name”, and enter patient name through the soft keyboard (Letters: not more than 20 characters) .
3. Select “Patient ID”, and enter the patient ID through the soft keyboard (Letters: not more than 20 characters).
4. Select “Case Number”, and enter the case number through the soft keyboard (Letters: not more than 20 characters) .
5. Select “Gender”, and set the patient’s gender.
6. Select “Patient Type”, and set the patient category as needed: Adult and Pediatric.
7. Select “Pace Maker”, and set whether the patient wears a pacemaker.

8. Select "Height(cm)", and set the patient's height via the pop-up keyboard on the screen(Range: 0 ~ 250).
9. Select "Weight (kg)", and set the patient's weight via the pop-up keyboard on the screen(Range: 0 ~ 350).
10. Select "Blood Type", and set the patient's blood type: A, B, AB or O.
11. Select "Admission Date (MM-DD-YYYY)", and set the date of admitting the patient.
12. Select "Birthday (MM-DD-YYYY)", and set the birth date of the patient.

After setting, select "OK" to save the current setting or select "Cancel" and do not save the current setting.

4.4 Discharging a patient

To discharge a patient, operate as follows:

In the "Patient" menu, select "Discharge Patient" → "Warning" message → "OK" to finish the operation of discharging a patient.

After the patient is discharged, all the information of the patient stored in the monitor will be cleared. Therefore, discharge the patient only when needed.

4.5 Clear alarms

To clear alarms, operate as follows:

In the "Patient" menu, select "Clear Alarms" → "Warning" message → "OK" to finish the operation of clear alarms.

After the alarm is cleared, all the information of alarms stored in the monitor will be cleared. Therefore, clear alarm only when needed.

4.6 Clear trend

To clear trend, operate as follows:

In the "Patient" menu, select "Clear Tabular Trend" → "Warning" message → "OK" to finish the operation of clear tabular trend.

After the tabular trend was cleared, all the information of tabular trend stored in the monitor will be cleared. Therefore, clear tabular trend only when needed.

4.7 Clear NIBP trend

To clear NIBP trend, operate as follows:

In the "Patient" menu, select "Clear NIBP Trend" → "Warning" message → "OK" to finish the operation of clear NIBP trend.

After the NIBP trend was cleared, all the information of NIBP trend stored in the monitor will be cleared. Therefore, clear NIBP trend only when needed.

5 Display format

The monitor has four display format, which are “Normal Screen”, “Big ECG Screen”, “Big font Screen”, and “ECG 7-Lead Full-Screen”. The user can select the display format according to needs, and get different screen information.

5.1 Selecting user interface

Select the user interface as follows:

- Select  [Displays] smart hotkey → Screen Select;
- Select the display format according to needs:
 - “Normal Screen”: Standard interface.
 - “Big ECG Screen”: Big ECG interface.
 - “Big font Screen”: Big font interface.
 - “ECG 7-Lead Full-Screen”: ECG 7-Lead Full interface.

5.2 Display description

5.2.1 Normal display format

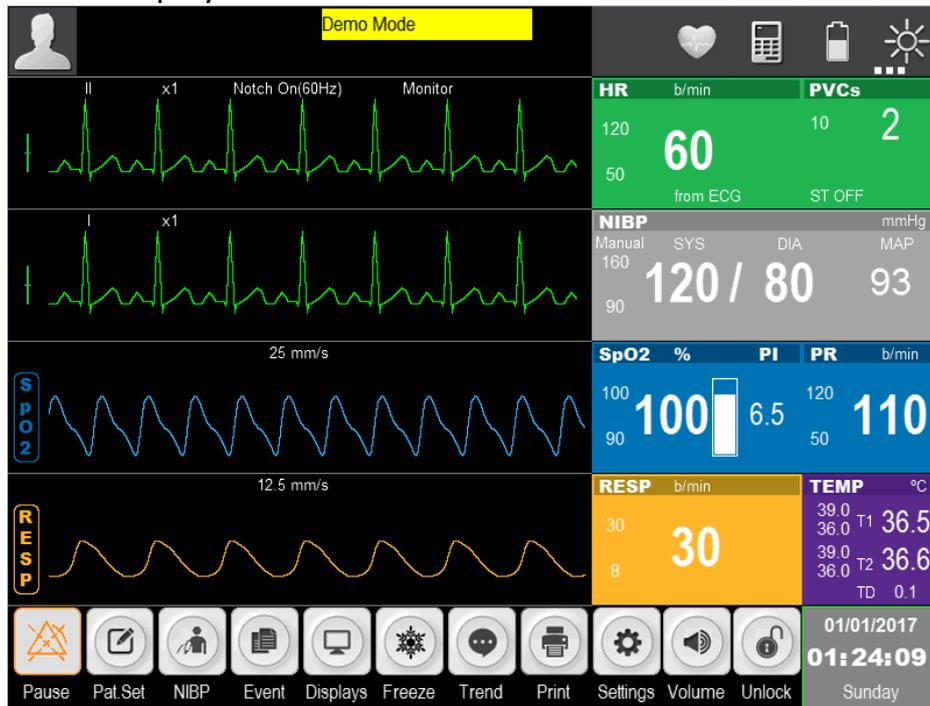

Figure 5-1: Standard Display

The normal display provides the parameter wave being monitored and the parameters displayed in the parameter area. This is the basic display of the monitor. In this display mode all parameters, two ECG waves, one blood oxygen saturation percentage wave, one respiratory wave are displayed.

5.2.2 Big ECG format

The big ECG format is as shown in Figure 5-2.

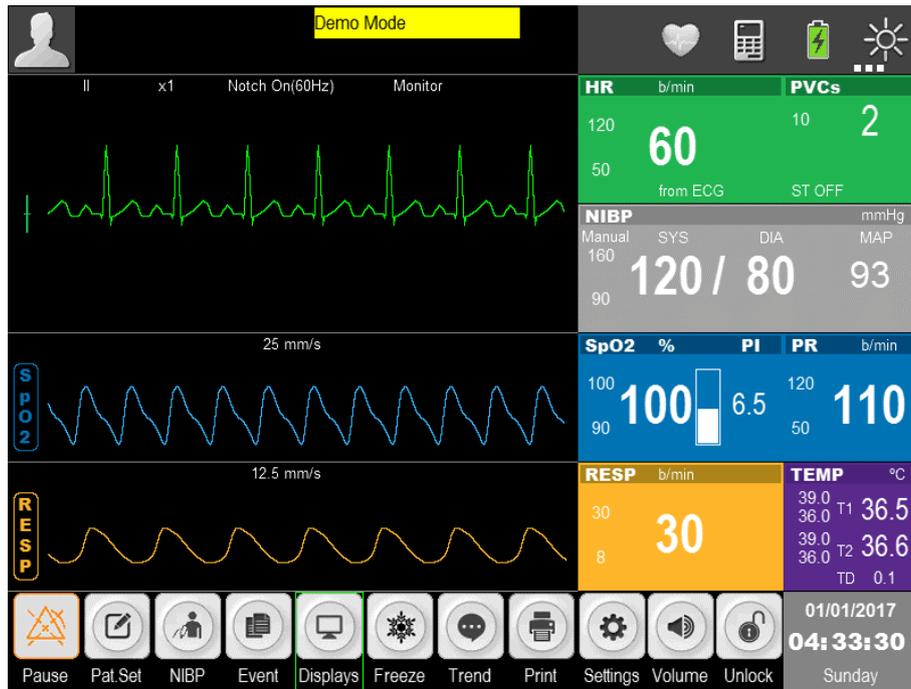

Figure 5-2: Big ECG format

5.2.3 Big font format

The big font format is as shown in Figure 5-3.

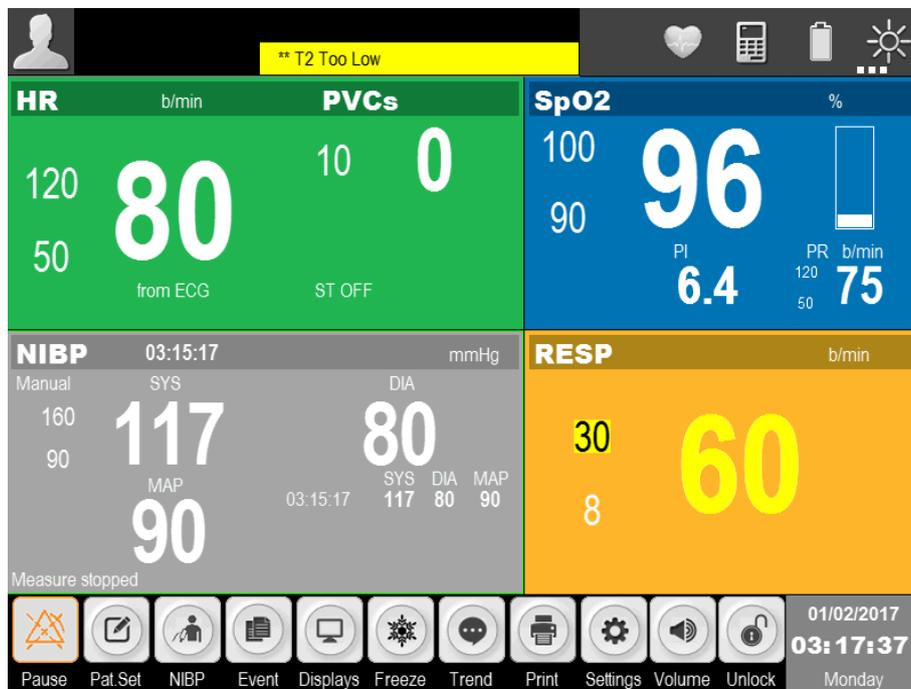

Figure 5-3: Big font format

5.2.4 ECG 7-Lead full screen format

The ECG 7-Lead full screen format is as shown in Figure 5-4.

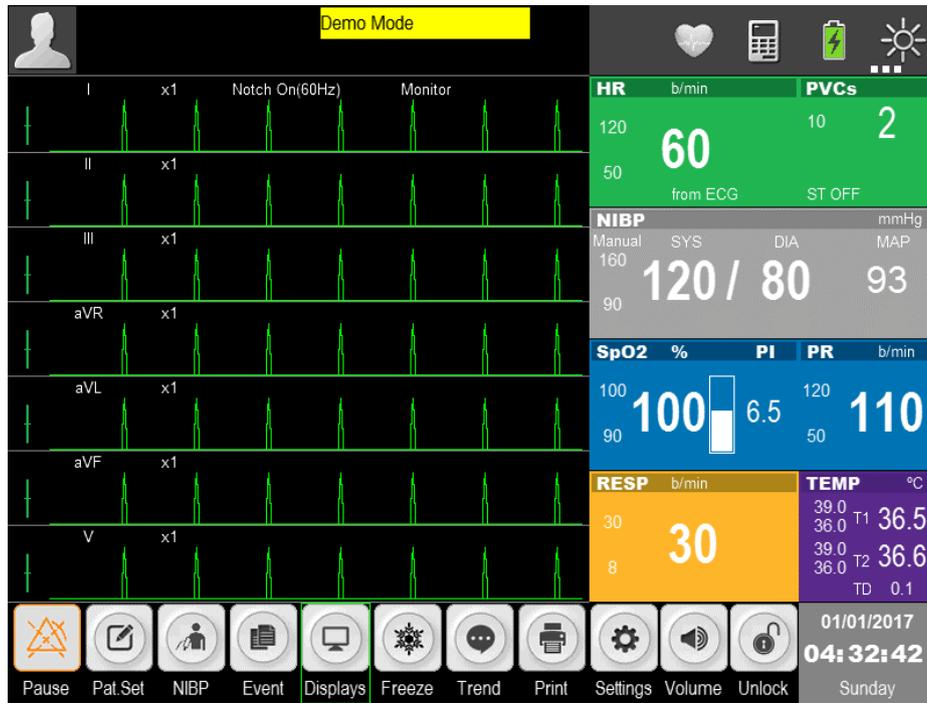

Figure 5-4: ECG 7-Lead full screen format

6 Alarm

Alarm means that the monitor prompts the medical staff through sound and light when the abnormal changes in vital signs are monitored or the monitor has a failure or is unable to monitor the patient successfully.

 **WARNING**

- In any single region (e.g. ICU), it has potential danger if the same or similar devices use different alarm setup.
-

- After setting, the alarm and other parameters of the monitor won't be lost when the system is power off, unless modified manually. Connect the power again and turn on the monitor, it will resume normal working, and the alarm and other parameters remain unchanged.

6.1 Alarm types

According to the nature of the alarm, the alarms of the monitor can be divided into physiological alarms, technical alarms and prompt messages.

➤ Physiological alarms

A physiological alarm is usually triggered when a physiological parameter of the patient exceeds the alarm limit or the patient has physiological abnormalities. The information of physiological alarm is displayed in the physiological alarm area on top of the screen.

➤ Technical alarms

Technical alarm is also known as a system error message, which is caused by improper operation or system failure resulting in system malfunction or monitoring result distorted. The information of technical alarm is displayed in the technical alarm area on top of the screen.

➤ Prompt messages

Strictly speaking, the prompt messages are not alarms. The monitor also will display some information associated with system status in addition to the physiological alarms and technical alarms, and generally such information do not involve the patient's vital signs. The prompt messages generally appear in the technical alarm area and parameters area.

6.2 Alarm condition priorities

According to the severity of the alarm conditions, the physiological alarms of the monitor can be divided into high priority, medium priority and low priority.

➤ High priority alarms

The patient is in critical condition that is life-threatening, and should be immediately rescued, or the monitor has a serious mechanical failure or malfunction, causing it unable to detect the patient's critical state and endangering the patient's life.

➤ Medium priority alarms

The patient's physiological signs are abnormal and appropriate measures or treatment should be taken immediately, or although it won't endanger the patient's life, the mechanical failure or disoperation of the monitor will affect the normal monitoring of key physiological parameters.

➤ Low priority alarms

The patient's physiological signs are abnormal and appropriate measures or treatment may need to be taken, or certain monitoring function is invalid due to mechanical failure or disoperation, but it won't endanger the patient's life.

The priority of all technical alarms and some physiological alarms have been set in the monitor at the factory and cannot be modified by the user. The levels of some physiological alarms can be modified.

6.3 Alarm mode

When an alarm occurs, the monitor uses the following audible or visual alarm to prompt the user:

- Visual alarm
- Audible alarm
- Alarm info
- Parameter flashing

Of which, the visual alarm, audible alarm, and alarm information distinguish the alarm levels in a different manner respectively.

6.3.1 Visual alarm

When an alarm occurs, the alarm indicator will flash in different colors and frequencies to prompt the alarm priority.

- High priority alarm: Red, fast flashes.
- Medium priority alarm: Yellow, slow flashes.
- Low priority alarm: Yellow, lit without flashing.

6.3.2 Audible alarm

An audible alarm is that the monitor prompts the alarm priorities with different sound characteristics when an alarm occurs.

- High priority alarm: Beep-beep-beep--beep-beep----beep-beep-beep--beep-beep
- Medium priority alarm: Beep-beep-beep
- Low priority alarm: Beep

6.3.3 Alarm information

Alarm information displayed on the physiological or technical alarm area of the monitor indicates the corresponding alarm information when an alarm occurs. The system will distinguish the alarm priority with different background colors:

- High priority alarm: Red
- Medium priority alarm: Yellow
- Low priority alarm: Yellow

The following flags in front of physiological alarms are used to distinguish the alarm priorities.

- High priority alarm: ***
- Medium priority alarm: **
- Low priority alarm: *

6.3.4 Parameter flashing

When the physiological parameter values in the parameter area will flash once per second, and the upper limit and lower limit of the parameter will also flash at the same frequency, it indicating that the parameter exceeds the upper limit or lower limit.

6.4 Alarm states

In addition to the above alarm modes, you can also set the monitor to the following three alarm states as needed, and display different alarm icons on the screen:

-  Alarm Reset
-  Alarm sound off
-  Alarm pause
-  Alarm off

6.4.1 Alarm reset

Select  button, and you can temporarily turn off the alarm sound of currently occurring physiological alarms of the monitor, but the alarm information is still retained. For technical alarms, clear the alarm state, display alarm prompt information, the alarm state icon area displays the  icon. When a new physiological alarm or technical alarm occurs, the alarm reset is automatically canceled.

6.4.2 Alarm sound off

The alarm sound can be turned off through the following operations:

- Select  [Settings] smart hotkey → “Settings”.
- Select “User Maintenance >>” → enter the password and confirm → “User Maintenance” menu.
- Select “Alarm Param >>” → “Alarm Param” menu.
- Set “Minimum Alarm Volume” to “0”. “Minimum Alarm Volume” range from 0 to 9, the default value is 1.
- Select  [Volume] smart hotkey → “Volume Setup” menu.
- Set “Alarm Volume” to “0”.

When the alarm sound is turned off, the alarm state area on the screen shows the  icon.

If “Minimum Alarm Volume” is larger than 0, the system will cancel alarm sound off state.

WARNING

- When the alarm is off, and the alarm reminder signal is on, the system will have alarm reminder tone.
-

6.4.3 Alarm pause

Press the  [Pause] smart hotkey or  [Alarm pause] key on the monitor panel to temporarily stop the alarm of the monitor in the following steps:

-  [Pause] smart hotkey will appear magnified and reverse colored  icon.
- The light alarm and audible alarm of the physiological alarms are suspended, and the alarm information is not displayed.
- The remaining time of alarm pause is displayed in the physiological alarm area.
- Alarm parameters and upper / lower limit stop flashing.
- The audible alarm and light alarm of technical alarms are suspended, but the alarm message is still displayed.

After the alarm pause is finished, the monitor will automatically cancel the alarm pause state.

During the alarm pause, you can also press  [Pause] smart hotkey or  [Alarm pause] key on the monitor panel to cancel the alarm pause manually.

You can set the alarm pause time as follows:

- Select  [Settings] Smart Hotkey or press  [Setting] key on the monitor panel → "Settings".
- Select "User Maintenance >>" → enter the password and confirm → "User Maintenance" menu.
- Select "Alarm Param >>" → "Alarm Param" menu.
- Select "Alarm Pause Time", and set the alarm pause time.
 - "1min" / "2min" / "3min" / "4min" / "5min" / "10min" / "15min" "Permanent". By default, the alarm pause time is 2 minutes.
 - "Permanent" means alarm off.
 - It is recommended that the SpO2 alarm pause time shall not more than two minutes.

6.4.4 Alarm off

As shown in 6.4.3, if the “Alarm Pause Time” is set to “Permanent”, press the  [Pause] smart hotkey or  [Alarm pause] key on the monitor panel, and the monitor will turn off the alarm. In this case, except the alarm prompt characteristics maintained in alarm pause state:

-  [Pause] smart hotkey will appear magnified  icon.
- The physiological alarm area displays “Alarm Pause”.

You can press the  [Pause] smart hotkey again to manually cancel the alarm off.

If the monitor is in the alarm state of suspension or high priority technical alarm is triggered, the alarm and the alarm off pause are automatically canceled.

 **WARNING**

- When the alarm volume is set to ‘0’ or the alarm pause time is set to permanent, the monitor does not sound an alarm when an alarm occurs. Therefore, the operator should use this feature carefully.
-

6.5 Alarm setup

6.5.1 Setting the alarm delay time

To limit alarm of continuous measurement parameter, you can set the alarm delay time. If the alarm condition disappears during the delay period, the monitor will not generate an alarm. In "Alarm Param" menu, select "Alarm Delay" time and "ST Alarm Delay" time.

The specific operation is as follows:

- Select  [Settings] smart hotkey or press  [Setting] key on the monitor panel → "Settings".
- Select "User Maintenance >>" → enter the password and confirm → "User Maintenance" menu.
- Select "Alarm Param >>" → "Alarm Param" menu.
- Select "Alarm Delay", and set the alarm delay time as needed:
 - "Off": Turn off the alarm delay.
 - "1s" / "2s" / "3s" / "4s" / "5s" / "6s" / "7s" / "8s": Alarm delay time is 1 sec, 2 sec, 3 sec, 4 sec, 5 sec, 6 sec, 7 sec or 8 sec. By default, the alarm delay time is 4 seconds.
- Select "ST Alarm Delay", and set the ST alarm delay time as needed.
 - "Off": ST alarm delay is off
 - "10s" / "20s" / "30s" / "45s" / "1min" / "2min" / "3min": ST alarm delay time is 10 sec, 20 sec, 30 sec, 45 sec, 1 min, 2 min or 3 min. By default, the ST alarm delay time is 20 seconds.

6.5.2 Setting the alarm reminder signal and alarm reminder interval

The alarm reminder signal can be turned on or off. When the alarm is off and the alarm sound is off, and then the alarm reminder signal is on. You can set the alarm reminder interval as needed: "1min" / "2 min" / "3 min".

The specific operation is as follows:

- Select  [Settings] Smart Hotkey → "Settings" .
- Select "User Maintenance >>" → enter the password and confirm → "User Maintenance" menu.
- Select "Alarm Param >>" → "Alarm Param" menu.
- Select "Alarm Reminder Signal", and set the alarm reminder signal as needed:

- “On”: The alarm Reminder Signal is on.
 - “Off”: The alarm Reminder Signal is off.
- Select “Alarm Reminder Interval”, and set the alarm reminder interval as needed:
- “1min” / “2 min” / “3 min”: Alarm reminder interval is 1 min, 2 min or 3 min. By default, the alarm reminder interval is 3 min.

6.5.3 Setting a parameter alarm

You can set the parameter alarm for every alarm separately. For SpO₂, as an example, select “Alarm Setup >>” in the “Settings” menu and select “SpO₂” and enter the SpO₂ alarm setup menu.

1. Turn on / off alarm

- Select “Alarm Switch” and set the alarm switch as follows:
- “On”: Turn on SpO₂ alarm; when the parameter alarm occurs, the monitor will prompt according to the set alarm level.
 - “Off”: Turn off SpO₂ alarm;  icon is displayed in the parameter area, and the monitor won't prompt the parameter alarm.

2. Set the alarm priority

- Select “Alarm Level”, and set the alarm priority as follows:
- “Mid”: Set the alarm priority to medium.
 - “High”: Set the alarm priority to high.

Note: Regulatory requirements, the parameter (ECG, blood oxygen saturation, blood pressure) can set the alarm priority high and mid.

3. Set the alarm limit

In any cases, the alarm system only allows setting the values within the effective range of the system, and the upper alarm limit must be higher than the lower alarm limit.

- Select “SpO₂ Low Limit” and set the lower limit of SpO₂ alarm.
- Select “SpO₂ High Limit” and set the upper limit of SpO₂ alarm.
- Select “PR Low Limit” and set the lower limit of PR alarm.
- Select “PR High Limit” and set the upper limit of PR alarm.

Type	Adults		Pediatric	
	Range	Default	Range	Default
SpO2 Low Limit	0-99	90	0-99	90
SpO2 High Limit	1-100	100	1-100	100
PR Low Limit	15-299	50	15-349	75
PR High Limit	16-300	120	16-350	160

4. Restore default alarm setup

- Select “Default”, and restore the alarm setup to the factory setup.

NOTE

- When setting the upper and lower alarm limits, confirm the patient category and set its range according to the clinical need. If the setting exceeds the alarm limits, the alarm system will fail easily.
 - When the alarm limit is turned on, and the upper and lower alarm limits are manually set, the monitor will display the upper and lower alarm limits continuously, and the initial alarm preset value will not be provided additionally.
-

6.6 Latch alarm

Physiological alarms can be set to “Latching” or “No latching”.

- “Latching”: Even if the cause of physiological alarm is cleared, the system will still be “latched”, that is, continue to display the alarm information corresponding to physiological alarm, the alarm sound also continues, but the alarm mode has the following changes:
 - Parameters and upper or lower alarm limit are no longer flashing.
 - Display the time that the latest alarm was triggered after the alarm message in the physiological alarm area.
- “No latching”: After the causes of physiological alarm are cleared, the system will no longer prompt the physiological alarm.

The default alarm of the system is no-latching alarm. You can set the alarm as latching or no-latching in the following steps.

- Select  [Settings] smart hotkey or press  [Setting] key on the monitor panel → “Settings”.
- Select “User Maintenance >>” → enter the password and confirm → “User Maintenance” menu.
- Select “Alarm Param >>” → “Alarm Param” menu.
- Select “Latching Alarm”, and set the alarm as needed:
 - “Latching”: Latching alarm.
 - “No latching”: Non-latching alarm.

6.7 Manual event

In the patient monitoring process, some events may have an impact on the patient, resulting in changes of some monitoring waves or parameters. In order to assist in the analysis of these effects, you can manually record these events through the  [Event] smart hotkey, and then view it in the event review, refer to 15.4 Event Review for detailed operation.

6.8 Alarm record

When the monitor's machine alarm system is powered down, all alarm records are not saved.

Physiological alarm can store 200 alarm records, if full of 200, the latest alarm records will replace the beginning of the record;

Technical alarm can store 100 alarm records, if full of 100, the latest alarm records will replace the beginning of the record.

7 ECG

7.1 Overview

Electrocardiogram (ECG) is produced by the continuous electrical activity of the patient's heart, and displayed with wave and numeric on the monitor in order to accurately assess the physiological state of the patient at the time. The ECG cable should be connected properly, so as to obtain a correct measurement value and normal display. This monitor can simultaneously display 7 ECG waves.

Patient cable consists of two parts.

- Wires connected to the monitor
- ECG electrodes connected to the patient

Connect to the monitor with five lead ECG cable, and ECG can display two different waves by adjusting the two leads. You can use the control knob to change the lead name on the left of the ECG wave on the screen and select the lead to be monitored.

The parameters displayed in the parameter area of the monitor include heart rate (HR), ST segment measurements and arrhythmia counts per minute. All these parameters can be used as alarm parameters.

The monitor is designed for defibrillation proof, so the monitor operates normally after defibrillation.

NOTE

- In the factory setup, ECG wave display in the first two waves from top in the wave area in the normal display format.
-

7.2 Safety information

WARNING

- To monitor ECG signal, ECG cable and ECG electrodes specified in this manual must be used.
 - When connecting the electrodes or patient cable, make sure that the patient is absolutely not connected with any other conductive parts or in contact with the ground. In particular, make sure that all the ECG electrodes, including the neutral electrodes, are attached to the patient and prevent them from contact with the conductive parts or ground.
 - When using electrosurgical (ES) equipment, users should put ECG electrodes at middle of the ES earthing plate and ES knives to prevent from burns. Cables of ES equipment cannot be wrapped with ECG cables together.
 - During use of ES equipment, don't put electrodes near the earthing plate of such equipment, otherwise ECG signals will be much disturbed.
 - For patients who wear a pace maker, pacing pulse analysis must be turned on. Otherwise, the pacing pulse may be counted as a normal QRS wave, make the ECG signal too weak to detect the alarm.
 - Periodically check the skin that the electrode is placed at. If there is any sign of allergy or irritation, replace the electrode or change the placement position.
 - Electrosurgical (ESU) device interference, defibrillator discharge
 - When the patient needs defibrillation, do not use non-defibrillator type ECG cables. For defibrillation protection, please use the accessories specified by manufacturer. (Refer to Chapter 17. Accessories)
 - During defibrillation, the operating personnel shall not touch the patient, tables and instrument.
 - During defibrillation, the ECG cable connected with the patient's body may be damaged. Check if the function is normal again before using these cables.
 - The monitor will recover within 10 seconds after defibrillation and will not lose any stored data. During electrosurgery or defibrillation, the measurement accuracy may be temporarily reduced. This does not affect the safety of the patient or the instrument.
 - Do not expose the monitor to X-ray or strong magnetic fields (e.g. MRI).
-

7.3 Monitoring steps

7.3.1 Preparation

Before placing the electrode, prepare the patient's skin in the following steps.

- Skin preparation: Since the skin is a poor conductor, it is very important to treat the patient's skin for electrode placement appropriately to make good contact between the electrode and the skin. Select the flat position with less muscles for the electrode placement, and refer to the method below for treatment of the skin:
 - Remove the body hair at the position for electrode placement.
 - Gently rub the skin at the position for electrode placement to remove dead skin cells.
 - Wash the skin thoroughly with soap and water (do not use ether and pure alcohol, as this will increase the skin's impedance).
 - Dry the skin completely before placing the electrode.
- Install the spring clip or stud prior to the placement of the electrodes.
- Place the electrode on the patient.
- Connect the ECG cable and ECG interface.

 **WARNING**

- Check if the lead is adequately attached and do not have any damage before monitoring. When the ECG cable is unplugged, the screen will display "ECG Lead Off" prompt, and trigger an audible and visual alarm.
-

7.3.2 Selecting lead

- Select the ECG parameter area or wave area → "ECG Setup" menu.
- Select "Other Setup >>" → "ECG Other Setup" menu.
- Select "Lead Type", and select the ECG lead as needed.
 - "3-Lead": 3-lead; ECG wave options: I, II, III.
 - "5-Lead": 5-lead; ECG wave options: I, II, III, AVR, AVL, AVF, V.

7.3.3 Lead name and corresponding color

The lead names in European standard and U.S. standard (represented with R, L, N, F, C in European Standard, and represented with RA, LA, RL, LL, V in the U.S. standard) are shown in Table 9 -1.

Table 7-1: Lead Name in European Standard and American Standard

European Standard (EN)		American Standard (AHA)	
Lead Name	Color	Lead Name	Color
R	Red	RA	White
L	Yellow	LA	Black
F	Green	LL	Red
N	Black	RL	Green
C	White	V	Brown

7.3.4 Installing the electrodes

➤ 3-lead

The electrode placement position of 3-lead is shown in Fig. 7-1.

- R/RA electrode: placed below the clavicle, near the right shoulder.
- L/LA electrode: placed below the clavicle, near the left shoulder.
- F/LL electrode: placed on the left abdomen.

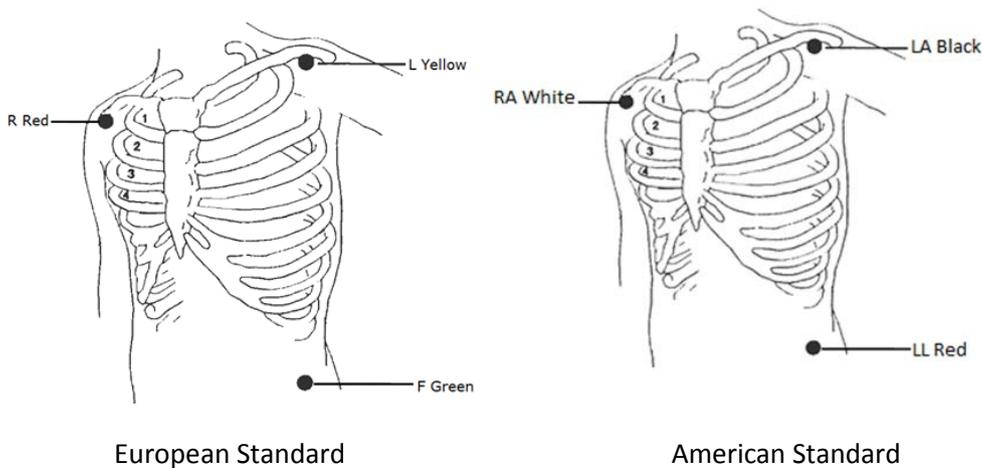

Figure 7-1: 3-Lead placement method

➤ 5-lead

The electrode placement position of 5-lead is shown in Fig. 9-2:

- R/RA electrode: placed below the clavicle, near the right shoulder.
- L/LA electrode: placed below the clavicle, near the left shoulder.
- N/RL electrode: placed on the right abdomen.
- F/LL electrode: placed on the left abdomen.
- C/V electrode: placed on the chest wall.

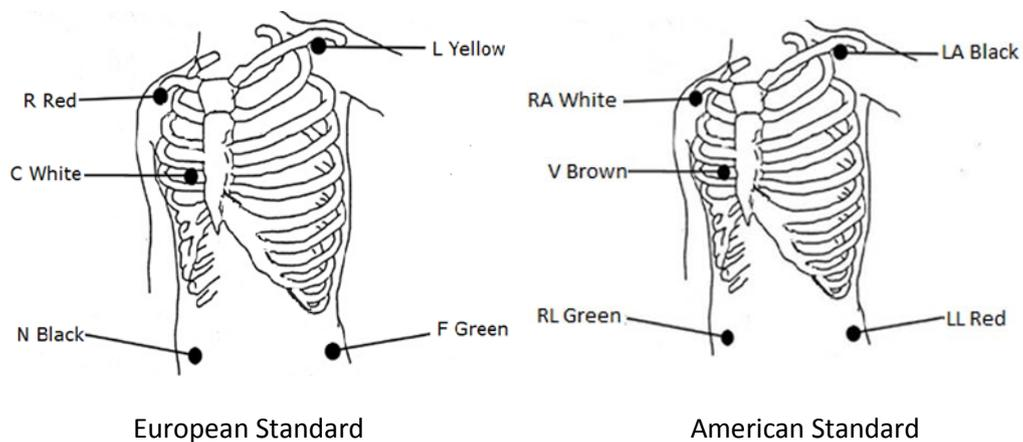

Figure 7-2: 5-Lead placement method

NOTE

- To ensure the patient safety, all leads must be connected to the patient.
 - If the electrodes are attached correctly, but the ECG wave is not accurate, then replace the lead.
 - Interference from ungrounded instrument near the patient and ESU may cause waveform problem.
-

7.3.5 Checking the pacemaker

Before ECG monitoring, it is very important to set the pace maker state of the patient properly. If the patient has a pacemaker, set "Pace Maker" to "Yes", and the icon  displays in the patient information area. When the system detects a pacing signal, the " | " symbol will be marked in the top of the ECG wave.

You can change the pacing state in the following method:

- Select the patient information area to pop up the "Patient Info" menu, or select the  [Pat. Sat] smart hotkey and select "Patient Info" menu.
- Select "Yes" / "No" for "Pace Maker" as needed, indicating that the patient with or without pacemaker.

Diagnostic, Monitor, Surgery will not affect rejection of pacemaker pulses.

 **WARNING**

- For patients with pacemakers, the cardio tachometer may count the pacemaker pulse in case of a cardiac arrest or arrhythmias. Never rely solely on the cardio tachometer alarm. Closely monitor the patients with pacemaker. For the inhibition of the device on pacemaker, refers to this manual.
-

7.4 ECG display

➤ ECG wave display

The monitor displays two ECG waves on the normal screen. Fig. 7-3 below is the monitoring interface of 5-lead, and is for reference purposes only. The graphics displayed on your monitor may be slightly different.



Figure 7-3: ECG wave in normal display format

In addition, when “Pace Maker” is set to “Yes”, and the patient wears a pacemaker, the “|” symbol will be marked in the top of the ECG wave.

➤ ECG parameter display

The ECG parameter area of the monitor in the normal screen is shown in Fig. 9-4:

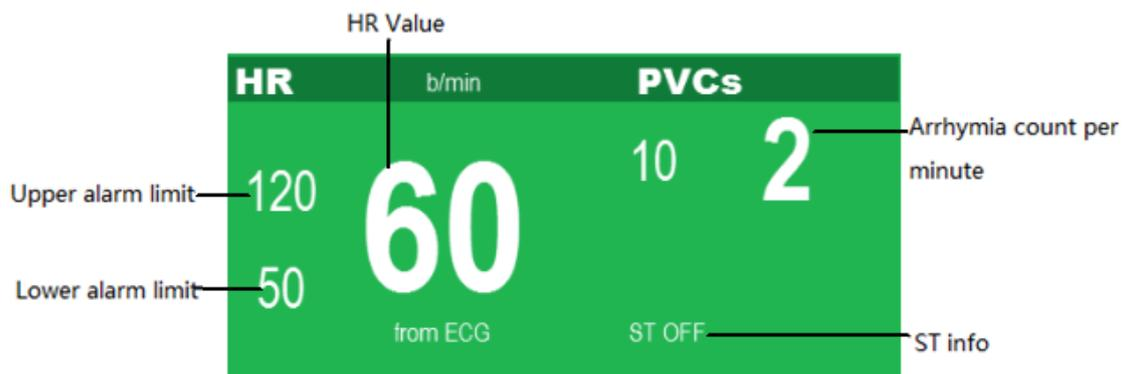

Figure 7-4: ECG parameter in standard display format

7.5 ECG setup

Select the ECG parameter area or wave ECG area or select the  [Settings] smart hotkey and “Parameter Setup >>” and “ECG Setup >>” to pop up the “ECG Setup” menu, which is as shown below. You can set the ECG through the “ECG Setup” menu.

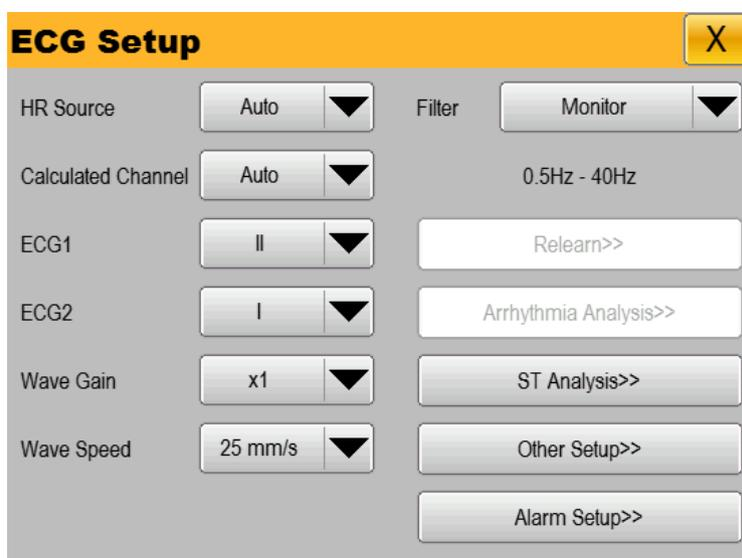

Figure 7-5: “ECG Setup” menu

- Select “HR Source”, and set the heart rate source.
 - “Auto”: Automatically select HR source.
 - “ECG”: Select ECG monitoring as the HR source.
 - “SpO2”: Select SpO2 monitoring as the HR source.
- Select “Calculated Channel” and select heart rate calculated channel.
 - “Auto”: Automatically select Heart Rate calculated Channel.
 - “I”: Select the first ECG waveform as the Heart Rate calculated Channel.
 - “II”: Select the second ECG waveform as the Heart Rate calculated Channel.
 - “V”: Select the third ECG waveform as the Heart Rate calculated Channel.
- Select “ECG1” / “ECG2” to set the display wave channel. Select “ECG1” / “ECG2”, and set the names of upper ECG wave and lower ECG wave on the screen.
 - ECG1/ECG2 should not be the source of the same wave, source waveform can be set I/II/III/AVR/AVL/AVF/V.
- Select “Wave Gain”, and set the ECG wave gain. When the wave is shorter, increase the

wave gain factor appropriately; when the wave is high or the peak cannot be displayed, reduce the wave gain appropriately, gain can be set Auto/ $\times 0.25$ / $\times 0.5$ / $\times 1$ / $\times 2$. When Big ECG interface is selected, gain can be set Auto/ $\times 0.25$ / $\times 0.5$ / $\times 1$ / $\times 2$ / $\times 4$.

- Select “Wave Speed”, and set the wave speed. The wave speed is “12.5mm/s”/“25mm/s”/“50mm/s”. The default is 25mm/s.
- Select “Filter”, and set the filter mode:
 - “Diagnostic”: Diagnostic mode
 - “Monitor”: Monitor mode
 - “Surgery”: Surgery mode
- Select “Arrhythmia Analysis>>”, and set the alarm switch, alarm level, alarm record.
- Select “ST Analysis>>”, and set the ST analysis, ST Channel, ST Alarm Setup.
 - “ST analysis”: You can set “Off” or “On”.
 - “ST Channel”: You can set “1”, “2”, “3”.
 - “ST Alarm Setup”: and set the alarm switch, alarm level, alarm record.
- Select “Other Setup>>”, and set the QRS Volume, Lead Type , Notch Filter, Pace Maker.

7.6 Alarm setup

Select “Alarm Setup >>” → “Alarm Setup” interface to set ECG related alarms; see 6.5 Alarm Setup for the setting method.

8 RESP

8.1 Overview

Thoracic electrical bio impedance is a method used for measuring the respiration. When the patient is breathing, the thoracic impedance between two ECG electrodes changes due to thoracic activity. The monitor generates a respiratory wave on the screen by measuring the changing impedance value. The monitor calculates the respiration rate (RR) according to the wave cycle.

8.2 Safety information

NOTE

- Respiration monitoring does not apply to patient with large range of activities, as this may lead to false alarm.
-

 **WARNING**

- Do not use anti-electric knife ECG cable for respiration monitoring.
 - Respiration measurement cannot identify the apnea because it will alarm if the next respiration is not detected in the predetermined period after last respiration, and therefore it cannot be used for diagnostic purpose.
-

8.3 Placing electrodes for respiration monitoring

Since the skin is a poor conductor, it is very important to treat the patient's skin for electrode placement appropriately to get better respiration signals. Refer to 7.3.1.

Respiration measurement uses standard ECG cable and electrode placement method. You can use different ECG cables (3-lead or 5-lead). Respiratory signal is measured between two ECG electrodes. If standard ECG electrode position is used, the two electrodes are R (right arm) and L (left arm) electrodes of I lead or R (right arm) and F (left leg) electrode of II lead.

NOTE

- For optimal respiration wave, R and L electrodes should be placed horizontally if I lead is selected for respiration measurement. R and F electrodes should be placed diagonally if II lead is selected for respiration measurement.
-

Figure 8-1 below shows the placement of 5-lead electrodes.

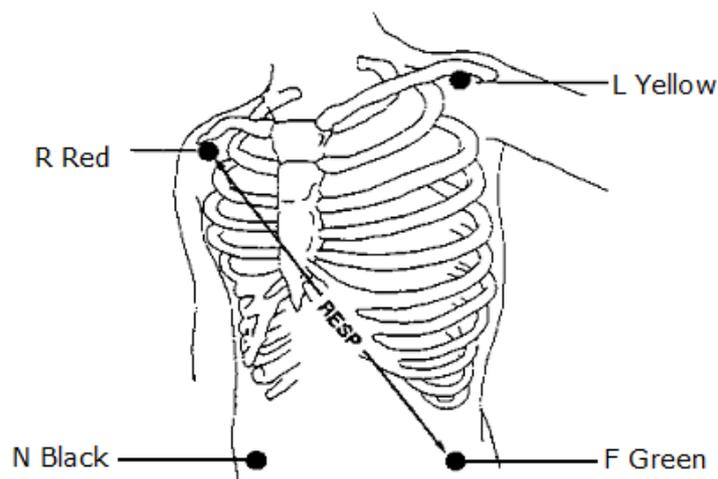

Figure 8-1: 5-lead respiration electrode placement

8.3.1 Adjusting position of respiration electrode

If you want to measure ECG and respiration simultaneously, you may need to adjust the position of the two electrodes for respiration measurement.

NOTE

- Adjusting the standard position of ECG electrodes will lead to changes in the ECG wave, and may affect the ST and arrhythmia analysis.
-

8.3.2 Cardiomotility superimpose

The effect of cardiomotility on the respiratory wave is called cardiomotility superimposing. When the respiration electrodes collect impedance changes caused by rhythmic blood flow, this will happen. Placing the respiration electrodes correctly will reduce this effect. The liver and ventricle should avoid the connection of respiration electrode, so that the heart or pulsating flow won't generate artifact.

8.4 Respiration display

Respiration wave is displayed as shown in Figure 8-2.

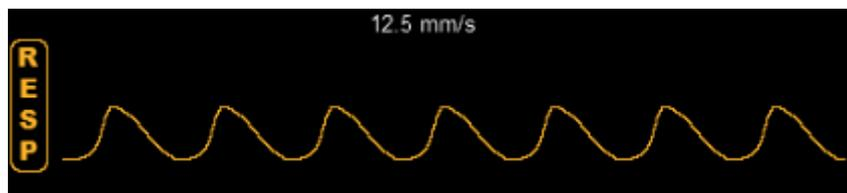

Figure 8-2: Respiration wave

Respiration parameters are displayed as shown in Figure 10-3.

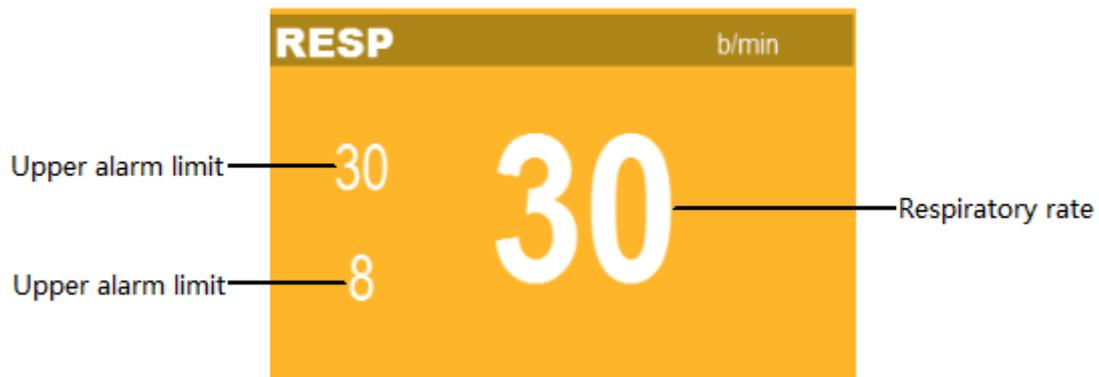

Figure 8-3: Respiration parameter display

8.5 Respiration setup

Select the RESP parameter zone or respiration wave area → “RESP Setup” menu, which is shown below. You can set respiration through “RESP Setup” menu.



Figure 8-4: “RESP Setup” menu

8.5.1 Setting apnea time

Apnea alarm is a high level alarm for monitoring the apnea. In “RESP Setup” menu, set “Apnea Delay” to an appropriate value and set the apnea alarm time. When the apnea time of the patient is longer than the set time, the monitor will trigger an alarm. Set time can be set “20s” / “25s” / “30s” / “35s” / “40s” / “45s” / “50s” / “55s” / “60s”, default apnea alarm time is 20s.

8.5.2 Adjusting wave gain

In “RESP Setup” menu, select “Wave Gain”, and set the wave gain: the greater gain, the higher wave amplitude. Gain can be set “x0.5” / “x1” / “x2”, the default is “x1”.

8.5.3 Setting sweep speed

In “RESP Setup” menu, select “Wave speed”, and set the sweep speed: the faster sweep speed, the smoother wave. The wave speed is “6.25mm/s” / “12.5mm/s” / “25mm/s”. The default is “12.5mm/s”.

8.5.4 Setting calculated channel

In “RESP Setup” menu, select “Calculated Channel”, and set the calculated channel. The calculated channels are “RA-LA”, “RA-LL”, “LA-RL” and “LL-RL”. The default is “RA-LA”.

8.5.5 Setting sensitivity

In “RESP Setup” menu, select “sensitivity”, and set the sensitivity. The sensitivity is “1” / “2” / “3” / “4” / “5”. The default is “2”.

8.6 Alarm setup

Select “Alarm Setup >>” → “Alarm Setup” interface to set respiration related alarms; see 6.5 Alarm Setup for the setting method.

9 PR

9.1 Overview

The mechanical activity of the heart causes arterial pulsation, and PR (pulse rate) value can be obtained by measuring this pulsation. PR value can be obtained through SpO₂ measurement.

The average calculation of the heart rate is the direct average method. The refresh rate is every 1 second.

9.2 Display

The color of PR parameter area is same as SpO₂ parameter color of PR source, as shown in Fig. 9-1:

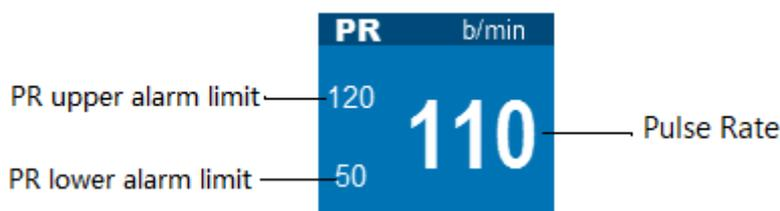

Figure 9-1: PR parameter display

9.3 Setting PR sound

Select SpO₂ parameter area or SpO₂ wave area → “SpO₂ Setup” menu;

Select “Pulse Volume” to set “Pulse Volume” to 0~9. Select 0 to turn off the pulse volume, and select 9 to set the maximum volume.

NOTE

- HR sound has higher priority than PR sound. When HR makes a sound, PR won't. When HR sound set to 0, PR can make a sound.
-

9.4 Alarm setup

Select PR parameter area → “SpO₂ Setup” menu → “Alarm Setup >>” to enter the “Alarm Setup” interface, and set PR alarm switch, alarm level and upper/lower alarm limit. See 6.5 Alarm Setup for detailed setting method.

10 SpO₂

10.1 Overview

Blood oxygen saturation (SpO₂) is the percentage of oxyhemoglobin (HbO₂) capacity bound by oxygen in the blood in the total hemoglobin (Hb) capacity that can be combined, that is, the concentration of oxygen in the blood.

The principle for monitoring the pulse SpO₂ is to fix the probe fingerstall on the patient's finger or toe, use the finger (or toe) as a transparent container for hemoglobin, use 660nm wavelength red light and 950nm near-infrared light as the incident light, maximum output power is 300 mW, measure the light transmission intensity through the tissue bed, and calculate the concentration of hemoglobin and SpO₂.

The passing lights depend on a variety of factors, most of which are constant. However, one of these factors, the arterial blood flow, changes with time, as it is pulsating. By measuring the light absorbed during pulsating, it is possible to obtain the arterial blood SpO₂. Detection pulsation can give a "plethysmography" wave and pulse rate signal.

The main screen displays "SpO₂" value and "plethysmography" wave.

This monitor applies to measure SpO₂ of adults (>18 years) and pediatric (<18 years,>30 days). Contact SpO₂ probe to Patient's finger (or toe) to get "SpO₂" value and "plethysmography" wave.

SpO₂ function of this monitor has been calibrated in factory.

The monitor is defibrillation proof, so the monitor operates normally after defibrillation.

10.2 Safety information

WARNING

- Please use SpO₂ sensor specified in this Manual, operate in accordance with the Manual, and observe all warnings and precautions.
 - Before monitoring, check whether the sensor cable is normal. When SpO₂ sensor cable is unplugged from the socket, the screen will display "SpO₂ Sensor Off" error message, and trigger an audible and visual alarm simultaneously.
 - If the sensor or sensor packaging has signs of damage, do not use this SpO₂ sensor; return it to the manufacturer.
 - If there is carboxyhemoglobin, methemoglobin or dye diluted chemical, the SpO₂ value will have deviation.
 - When the patient has a tendency to hypoxia, use the oximeter to analyze blood samples in order to fully grasp the patient's condition.
-

-
- Do not put the sensor on limbs with arterial duct or intravenous tube.
 - Do not intertwine electrosurgical equipment cable with the sensor cable.
 - Avoid using the monitor and sensors while using the NMR equipment, in order to avoid severe burns to the patient as a result of induced currents.
 - During long time continuous monitoring of a patient, check the position of SpO₂ sensor once every 2 hours, and move properly when the skin changes or every four hours. Some patients may require more frequent inspection, such as patients with perfusion disorders or sensitive skin, because persistent and prolonged monitoring may increase unpredictable skin changes, such as allergies, redness, blistering or pressure necrosis.
 - When the measured pulse rate is not complete, then the "---".
 - Before using, verify compatibility between the monitor, probe and cable, otherwise it may cause injury to the patient.
 - Functional testers cannot be used to evaluate the accuracy of pulse oximetry and pulse oximetry.
 - SpO₂ low alarm limit cannot be less than 85.
-

NOTE

- Do not put the oxygen probe and blood pressure cuff on the same limb, because blood flow occlusion during blood pressure measurement will affect the SpO₂ readings.
 - The monitor cannot be used to verify the accuracy of SpO₂ probe and SpO₂ equipment.
-

10.3 Monitoring steps

1. Select the appropriate SpO₂ sensor according to the patient.
2. Turn on the monitor, and connect the SpO₂ lead wire to the monitor.
3. Clean the measurement site, such as finger with nail polish.
4. Put the SpO₂ sensor probe on the patient's body.
5. Select the appropriate alarm settings.
6. Start monitoring.

NOTE

- Turn on the monitor, plug in SpO₂ probe and connect patient's finger (or toe), monitor displays SpO₂ wave, "SpO₂ Pulse Search" displayed in the technical alarm area until the monitor measured SpO₂ value and pulse rate. "SpO₂ Search Timeout" displayed in the technical alarm area until the monitor measured pulse rate. Check the sensor mounting position, whether the sensor is damaged or sensor type. Reconnect the sensor or use new sensor.
-

10.4 Display

SpO2 parameter area is as shown in figure 10-1.

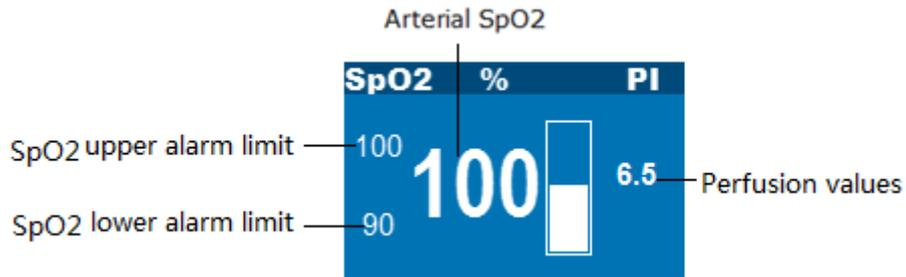

Figure 10-1: SpO₂ parameter display

SpO2 wave is as shown in figure 10-2.

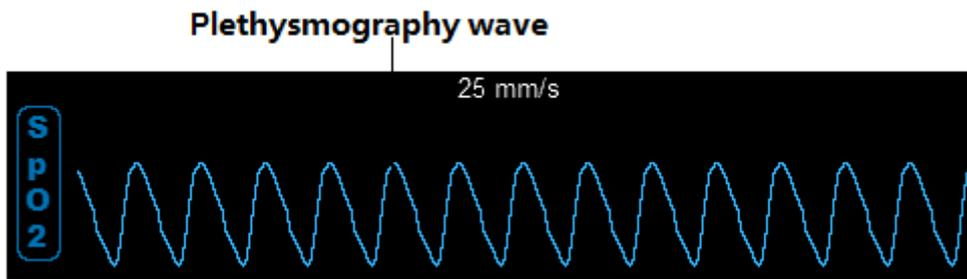

Figure 10-2: SpO₂ wave

10.5 Setting SpO₂

Select SpO₂ parameter area or SpO₂ wave area → “SpO₂ Setup” menu, which is shown below. You can set SpO₂ through “SpO₂ Setup” menu.

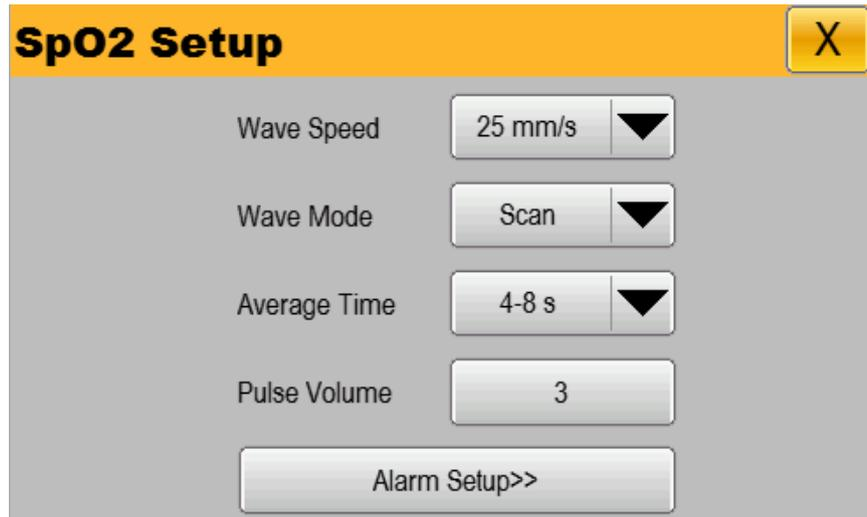

Figure 10-3: “SpO₂ Setup” menu

10.5.1 Setting wave speed

- Select “Wave Speed” and set wave speed to “12.5mm/s” or “25mm/s”; the faster speed, the smoother wave.

10.5.2 Setting wave mode

- Select “Wave Mode”, and set the wave drawing mode
 - “Scan”: Scan mode.
 - “Fill”: Fill mode.

10.5.3 Setting average time

- Select “Average Time”, and set the average time to “2-4s”, “4-8s”, “8-16s”.

10.5.4 Pulse volume

- The user can set the pulse volume. The pulse volume can be set to 0, 1, 2, 3, 4, 5, 6, 7, 8, or 9. By default, the pulse volume is set to 3.

10.6 Measuring influencing factors

During operation, the following factors can affect the accuracy of SpO₂ measurement:

- High-frequency radio wave interference, such as interference generated by the host system or interference from electrosurgery instrument connected to the system.
- Intravenous dye.
- Too frequent movement of the patient.
- External light radiation.
- Sensor is improperly installed or improperly in contact with the patient.
- Sensor temperature.
- The sensor is placed on limbs with blood pressure cuff, arterial duct or lumen tube.
- Concentration of non-functional hemoglobin such as carboxyhemoglobin (COHb) and methemoglobin (MetHb).
- Shock, anemia, hypothermia, and the application of vasoconstrictor drugs may reduce the arterial blood flow to a level that cannot be measured.
- The measurement also depends on the absorption of specific wavelengths of light by oxyhemoglobin and reduced hemoglobin. If there is any other substance that absorbs the same wavelength, the measurement may have false or low SpO₂ values, such as: carbon hemoglobin, methemoglobin, methylene blue, and indigo carmine.
- SpO₂ probe described in Annex is recommended.
- Operating environment limit: Operating temperature range: 5 ~ 40 °C, Humidity range: 30%~85% (non-condensing) Atmospheric pressure: 700hPa ~ 1060hPa.

10.7 Alarm setup

In “SpO₂ Setup” menu, select “Alarm Setup >>” to enter “Alarm Setup” interface, and set SpO₂ alarm switch, alarm level, upper and lower alarm limit. See 6.5 Alarm Setup for detailed setting method.

10.8 Technical description

- Accessories have passed the biocompatibility test and meet the requirements of ISO 10993-1.
- Fluke's index 2XL Oxygen Analyzer can be used to check the function of the monitor and can be used to assess the accuracy of the pulse rate but cannot be used to assess the accuracy of blood oxygen.
- Functional testers cannot be used to evaluate the accuracy of pulse oximetry probe and pulse oximetry.
- Measure the maximum temperature between the oxygen probe and the tissue contact surface : Measured as described in Annex BB of ISO 80601-2-61,the temperature is less than 41 ° C.

11 NIBP

11.1 Overview

The monitor uses oscillometric method to measure noninvasive blood pressure (NIBP).

The oscillometric method for measuring blood pressure is to inflate a cuff with a certain amount of pressure until the arterial blood flow has been completely blocked. As applied pressure decreases, the arterial blood flow which was completely occluded gradually opened, and completely opened. Then, the pulsation of the arterial vascular wall will generate a shock wave in the cuff. SBP, MAP, and DBP are obtained by measuring and analyzing cuff pressure oscillations when deflating.

- Produce first most clear signal - reflect SBP
- Oscillation amplitude reaches the peak - reflect MAP
- When the cuff pressure is suddenly lowered - reflect DBP

Measuring mode: manual, cycle, and continuous. Each mode shows systolic, mean and diastolic blood pressure.

- Manual mode

Using Manual mode start to measures by hand

- Automatic mode measures

Use manual mode to open automatic mode, then the measure will automatically turn to automatic mode after a certain time. During measurement, any error will stop the current automatic measurement, but not affect next automatic measurement unless the time interval less than 30s. If the time interval less than 30s, should delay the next automatic measurement, keep the interval more than 30s.

The time interval can be choose In Automatic mode as 1, 2, 3, 4, 5, 10, 15, 30, 60, 90, 120, 180, 240, 480 minutes.

- Continuous mode

Choose continuous mode, 5 seconds after complete a measurement start the next measurement, continue 5 minutes then stop. During measurement, any error will stop the continuous measurement. If the first measurement time is over 4 minutes and 40 seconds but less than 5 minutes, the continuous mode will stop before 5 minutes, if the first measurement time is over 5 minutes, the continuous mode will stop after 5 minutes.

The monitor is defibrillation proof, so the monitor operates normally after defibrillation.

11.2 Safety information

WARNING

- Do not carry out non-invasive blood pressure measurement on patients with sickle cell disease and skin damage or any expected damage. Do not measure NIBP on traumatic body part. This may cause further injury.
 - When pediatric patients are measured, in order to ensure the cuff pressure does not exceed its maximum measurement range of patient types (Adult mode: 300mmHg and Pediatric mode: 240mmHg), you must ensure that you have selected the correct patient type (see patient information menu settings). Using the wrong type of pattern is likely to endanger the patient to patient safety, as higher blood pressure levels for adults does not apply to pediatric.
 - For patients with severe coagulation disorder, determine if the automatic blood pressure measurement is carried out according to the clinical evaluation, since the friction of body and cuff may produce hematoma.
 - Do not install a cuff on the limbs with intravenous infusion or duct, because it may lead to tissue damage around the duct when the cuff is inflated and makes the infusion slow down or be blocked.
 - The inflatable tube connecting the blood pressure cuff and the monitor should be smooth without entanglement. The pressure generated by being kinked connection tubing may cause blood flow interference.
 - For patients with severe thrombotic disorders, determine whether to carry out automatic blood pressure measurement according to the clinical situations, since the limb bundled with a cuff may produce hematoma.
 - Measure blood pressure frequently will affect the distribution of blood flow, May endanger the safety of patients.
 - Check the patient's physiological condition before measure blood pressure, in order to ensure that long time measure will not damage the circulation of patients
 - For mastectomy patients, applying the NIBP cuff on the surgery side arm can cause lymphedema. Measure blood pressure on opposite side arm.
 - Pressurization of the cuff can temporarily cause loss of function of simultaneously used monitoring device on the same limb.
 - Measurement results may be affected by posture and mental state of the patient.
 - If there are doubts on the measurement results, please use other blood pressure measurements and compare, if necessary, contact the Equipment Division.
-

11.3 Measurement limits

According to the patient's condition, the oscillometric method has some limitations. This measurement is to look for the regular pulse waves generated by arterial pressure. If the patient's condition makes this detection method difficult, the measured value becomes unreliable, and pressure measurement time increases. The user should be aware that the following conditions may interfere with measurement method, making the pressure measurement unreliable or extend the time. In this case, the patient's condition does not allow measurement.

➤ Patient movement

If the patient is talking, moving, shaking or cramping, the measurement will be unreliable or even impossible, as these may interfere with the detection of arterial pressure pulse, and extend the pressure measurement time.

➤ Arrhythmia

If the patient shows arrhythmia which results in irregular heartbeat, the measurement will be unreliable and even cannot be done, and the pressure measurement time will be extended.

➤ Use of an artificial heart-lung machine

If a patient is connected to an artificial heart-lung machine, the measurement will be impossible.

➤ Pressure changes

If the arterial pressure pulse is being analyzed to obtain a measured value at a certain time and the blood pressure of the patient changes rapidly, the measurement will be unreliable or impossible.

➤ Severe shock

If the patient is in severe shock or hypothermia, the pressure measurement will not be reliable, because the decrease of blood flow to the periphery would cause decrease in arterial pulsation.

➤ Limit heart rate

If the heart rate is below 40bpm (beats / min) or above 240bpm (beats / min), the blood pressure measurement is impossible.

➤ Obese patients

A thick layer of fat around a limb blocks the arterial oscillation so that it cannot reach the cuff. The accuracy is lower than normal.

➤ Environmental Requirements

Measuring blood pressure should meet the environment range as follow:

ambient humidity 30% ~ 85%, no condensing,

ambient temperature 5 ~ 40°C,

Atmospheric pressure: 700hPa ~ 1060hPa.

NIBP performance and measurement accuracy will be affected beyond the range.

11.4 Measurement procedure

11.4.1 Prepare the measurement

1. Turn on the monitor, and check if it works properly.
2. Verify the patient category, and make changes if improper. Depending on the current patient type, the patient type is selected in the patient information interface.
3. Connect the blood pressure cuff extension tube to the monitor.
4. Select the cuff in accordance with the following method, make sure that the cuff is completely deflated, and then tie it to the upper arm or thigh of the patient.
 - Determine the limb circumference of the patient.
 - Select the appropriate cuff (marked with appropriate limb circumference). Cuff width should be 40% of the limb circumference or 2/3 of the upper arm length. The length of the inflated part of the cuff should be sufficient for 50%~80% around the limb.
 - Place the cuff on the upper arm or thigh of the patient, and ensure that the marking ϕ is located just above the appropriate artery. Make sure that the cuff does not wrap too tight around the limb, or it may cause distal discoloration or even ischemia.

11.4.2 Patient posture requirements during measurement

1. Sit comfortable or lie down relaxedly.
2. No crossing legs.
3. Back and elbow should be supported.
4. The center of NIBP cuff and the right atrium are at in the same level.
5. Remind patients, no talking during measurement and try to relax.

NOTE

- When have doubt about blood pressure measuring result, re-measure after the patient sit-in about 5 minutes. If still have doubt, replace the blood pressure measuring equipment and measure again.
 - The operator should be in the position where he/she can readily operate the sphygmomanometer.
-

11.4.3 Start/stop measurement

Use the  [NIBP start/stop] key on the monitor panel or  [NIBP] smart hotkey on the display to start / stop the blood pressure measurement.

11.4.4 Correcting measurement results

The position of limb blood pressure measurement should be in the same horizontal position of the patient's heart. Otherwise, correct the measurement results with the following correction method.

- If the cuff is above the heart level position, increase 0.75mmHg (0.10kPa) per centimeter of gap to the measured results.
- If the cuff is below the heart level position, subtract 0.75mmHg (0.10kPa) per centimeter of gap from the measured results.
- If the patient is obese or clothes are too thick, subtract 5mmHg ~ 10mmHg (0.65kPa ~ 1.3kPa) from the measured results.

11.5 NIBP display

NIBP measurement has no waveform display, and only displays NIBP measurement results in the parameter area, as shown in Fig. 11-1. The figure below is for reference only. The graphics displayed on the monitor may be slightly different.

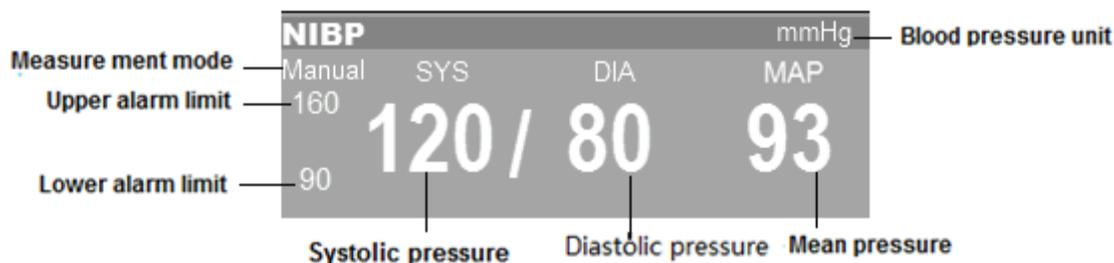

Figure 11-1: NIBP parameter display

11.6 Setting inflation pressure

If necessary, you can manually set the initial cuff inflation pressure as follows.

- Select the NIBP parameter area → “NIBP Setup” menu;
- Select “Initial Pressure”, and set the appropriate cuff pressure value. When the patient is adult, the pressure can be select from “140”, “160”, “180”. The default cuff pressure value is “160”.
- Select “Initial pressure”, and set the appropriate cuff pressure value. When the patient is pediatric, the pressure can be select from “140”, “160”. The default cuff pressure value is “140”.

11.7 NIBP reset

Select NIBP parameter area → “NIBP Setup” menu → Select “Reset”, and restore the inflation pressure of the blood pressure pump to currently configured initial settings. When the blood pressure pump is not working properly, but no warning is given, you can reset the blood pressure pump, and automatically restores the blood pressure pump.

11.8 Clean and disinfection method of NIBP cuff

If necessary, NIBP cuff and NIBP extension tube can be cleaned and disinfected together without separated

11.8.1 Cleaning method

1. Prepare enzyme cleaning agent, distilled water and 10% solvent, respectively in different spray bottle.
2. Sprinkle cleaning agent on NIBP cuff, connector and extension tube, keep 1 minute for the dry stains.
3. Use a soft cloth to wipe smooth face. Use soft hair brush to brush visible stain and irregular surface
4. Rinsed with copious amounts of distilled water.

NOTE

- Please be especially careful to clean the air ball and control valve of whole air system. Do not allow any liquid entering into reversing valve and saturated valve.
 - Don't use a soft cotton ball and fiber to clean this accessory because they will stick on the cuff and extension tube.
-

11.8.2 Disinfection method

1. Sprinkle bleach solution (Formula: the proportion of water and bleaching powder to 1:10) then keep 5 minutes
2. Wipe off excess bleach solution and elute with distilled water again
3. Natural dry cuff

11.9 Alarm setup

In "NIBP Setup" menu, select "Alarm Setup >>" to enter "Alarm Setup" interface, and set NIBP alarm switch, alarm level, upper and lower alarm limit. See 6.5 Alarm Setup for detailed setting method.

12 TEMP

12.1 Overview

The monitor has two temperature measurement channels; the temperature sensor will measure the body temperature, and calculate the difference between the body temperature data.

The monitor is designed for defibrillation proof, so the monitor operates normally after defibrillation.

12.2 Safety information

 **WARNING**

- Before monitoring, check if the probe cable is normal. Unplug the temperature probe cable from the jack, the screen will display “TEMP1 Sensor Off” and “TEMP2 Sensor Off” prompt and make an alarm sound.
 - Calibrate the temperature measuring instrument at least once every two years (or according to hospital procedures). When calibration is required, please contact Bistos.
-

12.3 Measurement steps

Please refer to the following steps:

1. Turn on the monitor and check if it works normally.
2. Select the appropriate temperature probe according to the patient category and measurement needs.
3. Insert the probe lead wire into the temperature probe interface.
4. Attach the probe to the patient properly.
5. Make sure that the alarm settings apply to the patient.

When measuring body temperature, temperature probe can be attached to body surface such as the neck, armpits, ears and other locations.

12.4 Measurement requirements

The normal measuring range of monitor is 0°C~50°C, and the accuracy is consistent in this range.

The environmental temperature range for body temperature measuring is 5°C~40°C. Get the right temperatures for the shortest measurement time is 40s, and the measuring interval is 1s.

⚠ WARNING

- Please measure the body temperature in the specified environment temperature range, or else it may be dangerous.
-

12.5 Temperature display

The monitor can display the body temperature of two channels (T1 and T2) and the alarm limits, difference between the two temperature (TD) and temperature units. Select Temp parameter area and open the [Temp Setup] menu.

Temperature display area is as shown below:

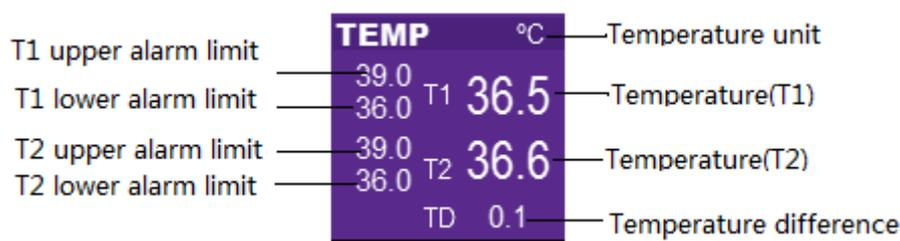

Figure 12-1: TEMP parameter display

⚠ WARNING

- The operator, prior to use, need to check the compatibility of the probe and thermometer. If the temperature value displayed by the monitor has significant difference from the body temperature under normal condition, please check if the probe resistance of the monitor matches the resistance set in the monitor system; if not, please replace a probe with appropriate resistance or adjust the monitor and select the appropriate resistance. Incompatible probe will affect the critical properties.
-

12.6 Setting temperature unit

-You can define your favorite temperature unit as follows:

- Select TEMP parameter area → “TEMP Setup” menu.

In the “TEMP Setup” menu, set “Unit” to “°C” or “°F”

12.7 Alarm setup

In “TEMP Setup” menu, select “Alarm Setup >>” to enter “Alarm Setup” interface, and set TEMP alarm switch, alarm level, upper and lower alarm limit. See 6.5 Alarm Setup for detailed setting method.

12.8 Technical description

Accessories have passed the biocompatibility test and meet the requirements of ISO 10993-1.

13 Review

The monitor provides up to 168 hours trend data review of all monitoring parameters, 1000 groups of NIBP measurement data and 200 physiological alarm events, 100 technical alarm events. The user can select trend chart or trend table to view trend change; or view the latest wave.

13.1 Reviewing trend chart

Select  [Trend] smart hotkey to enter [Trend] menu, and select [Graphic] to enter the following window.

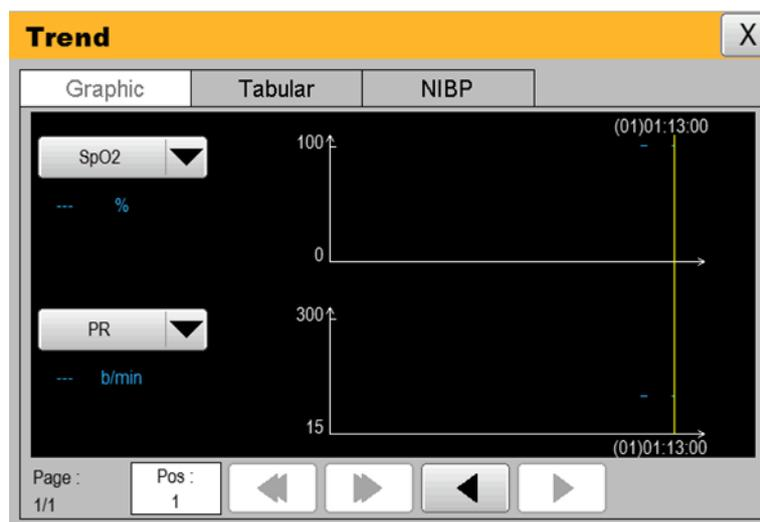
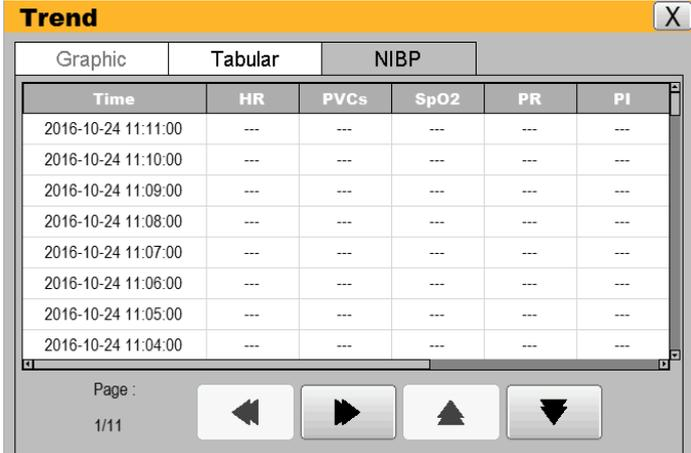

Figure 13-1: Trend chart

- In the trend chart, use the following method to select the parameter to be reviewed:
 - Select the parameter box, rotate the shuttle to select the parameters to be reviewed, press the shuttle, and set the parameter box as the parameter to be reviewed.
- Browse the trend chart in the following method:
 - Select  and  to move the trend cursor.
 - Select  and  to turn pages to left or right and move the trend chart.
 - The cursor top displays the current time corresponding to the current cursor position, and the left of the trend chart window displays the parameter values of the time, which will change automatically with the move of trend cursor.

13.2 Reviewing trend table

Select  [Trend] smart hotkey to enter “Trend” menu, select “Tabular” and enter the following window.



Time	HR	PVCs	SpO2	PR	PI
2016-10-24 11:11:00	---	---	---	---	---
2016-10-24 11:10:00	---	---	---	---	---
2016-10-24 11:09:00	---	---	---	---	---
2016-10-24 11:08:00	---	---	---	---	---
2016-10-24 11:07:00	---	---	---	---	---
2016-10-24 11:06:00	---	---	---	---	---
2016-10-24 11:05:00	---	---	---	---	---
2016-10-24 11:04:00	---	---	---	---	---

Figure 13-2: “Trend” table

➤ Browse the trend table in the following method:

- Select  and  to turn pages to left or right and move the trend table to observe the target parameters.
- Select  and  to turn pages up or down and move the trend table to observe more data.

13.3 NIBP measurement review

Select  【Trend】 smart hotkey to enter “Trend” menu, and select “NIBP” to enter the following window



Figure 13-3: NIBP measurement review

This window shows the measurement time of noninvasive blood pressure, systolic blood pressure “SYS”, diastolic blood pressure “DIA”, mean blood pressure “MAP” and pulse rate “PR”. The monitor can store 1000 sets of NIBP measurements in total.

➤ NIBP viewing method is as follows:

- Select  and  to turn pages up or down and move the trend table to observe more data.

14 Battery

14.1 Overview

The monitor has a built-in rechargeable battery to ensure that the monitor can also be used normally in case of patient transfer or power failure. When the monitor is connected to an DC power source, it will charge the battery no matter whether the monitor is turned on or not. In the case of power failure, the system will automatically use the battery to power the monitor to avoid interrupting the monitor working.

The battery icon on the screen indicates the battery status:



Battery is working properly and is fully charged.



Battery is working properly and the green part indicates the battery power.



Battery power is low, and requires charging immediately, or else the pulse oximeter will turn off automatically.



Battery is not installed.



Battery is properly installed and being charged.

The battery power can only maintain for some time. Low battery voltage will trigger a high level technical alarm “Battery Low”; in this case, connect the monitor to DC power and charge the battery.

14.2 Battery usage guide

Battery life depends on the frequency and time of use. If the battery maintenance and storage are proper, the lithium battery life is three years. If you do not use the battery properly, its life may be shortened. It is recommended to replace the lithium battery once every three years.

In order to ensure the maximum capacity of the battery, please note the following usage guide:

- Do not drop the battery.
- Check the battery performance once every two years. Before servicing the monitor or you suspect that the battery is the fault source, also check the battery performance.

 **WARNING**

- Keep the battery out of the reach of children.
 - Use only the designated battery.
 - If the battery is damaged or leaks, replace it immediately. Do not use a defective battery for the monitor.
 - Do not open the battery compartment. Only the qualified service personnel authorized by the manufacturer can open the battery compartment and replace or check the battery, and when it needs replacement, the replacement should be same model with established battery.
 - Do not disassemble the battery, throw it in fire, or short-circuit it. Battery fire, explosion and leakage may lead to personal injury. Do not touch the leaking battery with bare hand directly.
-

14.3 Checking battery performance

Please refer to the following steps to check the battery performance:

- Disconnect the monitor from the patient and stop all monitoring or measurement.
- Connect DC power to the monitor, and charge the battery for more than 4 hours uninterruptedly.
- Disconnect the DC power and power the monitor with battery until the monitor is turned off.
- Battery duration reflects the battery performance.

If the battery operating time is significantly shorter than the time stated in specifications, please contact our service personnel for replacing the battery.

 **WARNING**

- Do not open the battery compartment. Only the qualified service personnel authorized by the manufacturer can open the battery compartment and replace or check the battery, and when it needs replacement, the replacement should be same model with established battery.
-

14.4 Battery recycling

If the battery has visible damage or cannot store power, it should be replaced and recycled properly. Follow the appropriate regulations to dispose of used batteries.

 **WARNING**

- Do not disassemble the battery, throw it in fire, or short-circuit it. Battery fire, explosion and leakage may lead to personal injury. Do not touch the leaking battery with bare hand directly.
-

15 Caring and cleaning

15.1 Overview

In the using process, please make sure that there is no dust on or near your device. To prevent damage, please use the diluted detergents and disinfectants specified in this Manual, and use the lowest possible concentration. For the damage or accident caused by using other materials or methods, our company does not assume any responsibility.

15.2 Cleaning

The device should be cleaned regularly. In the heavily polluted environment, increase the frequency of cleaning. Before cleaning, please consult the hospital about device cleaning requirements.

Below are available cleaning agents:

- Diluted ammonia
- Diluted sodium hypochlorite (washing bleach)
- Diluted formaldehyde
- Hydrogen peroxide (3%)
- Ethanol (70%)
- Isopropanol (70%)

Before cleaning:

- Turn off the monitor and disconnect the power.
- Use a soft cotton ball to adsorb appropriate amount of cleaning agent and wipe the display screen.
- Use a soft lint-free cloth to adsorb appropriate amount of cleaning agent and wipe the surface of the device.
- If necessary, use a clean, dry, lint-free cloth to remove any excess detergent.
- Dry the device naturally in a ventilated cool environment.

 **WARNING**

- Before cleaning the monitor or sensor, turn off the power and disconnect the DC power.
-

-
- The monitor should be kept clean. It is recommended to regularly clean the enclosure surface and the display screen. Cleaning the enclosure with non-etching cleaner such as soap and water.
-

 **CAUTION**

- To avoid damaging the monitor:
 - Do not use strong solvents such as acetone.
 - Most cleaners must be diluted before use. Diluting should be according to the manufacturer's instructions.
 - Do not use abrasive materials (such as steel wool).
 - Do not allow any liquid entering into the enclosure, and never immerse any part of the device into liquid.
 - Do not leave any cleaning solution on the surface of any part of the device.
-

NOTE

- Wipe the monitor and sensor surface with medical alcohol, dry it naturally or with clean, dry, lint-free cloth.
 - Bistos is not liable for effectiveness of using these chemicals for infectious disease control. Please consult the infectious disease control officers or experts of the hospital for advice.
-

15.3 Disinfection

In order to avoid damage to the product, we recommend that the product is disinfected only when it is deemed necessary by the hospital maintenance procedures. We also recommend that the instrument to be disinfected must first be cleaned.

 **CAUTION**

- To prevent damage to the monitor, do not disinfect the monitor with gas (EtO) or formaldehyde.
-

16 Maintenance

⚠ WARNING

- If the hospitals or institutions using this instrument can't implement a satisfactory maintenance schedule, it will result in device failure and may endanger human health.
-

16.1 Checking

Check the following basic items before each using the monitor:

- Check for any mechanical damage.
- Check all exposed wires, insertions and accessories.
- Check all instrument functions that may be used for patient monitoring and ensure that the instrument is in good working condition.

If the instrument function has any sign of damage, do not use this monitor for any patient monitoring. Please contact the hospital's professional maintenance personnel or our customer service personnel.

Every 6-12 months or after each repair, a comprehensive examination must be performed by trained and qualified technical service personnel, including functional safety checks; the specific inspection items are as follows:

- Environment and power meet the requirements.
- Device and accessories have no mechanical damage.
- The power supply has no wear, and the insulation is good.
- Specified accessories are used.
- Alarm system is functioning correctly.
- Battery performance meets the requirements.
- Monitoring functions are in good working condition.
- Ground impedance and leakage current meet the requirements.

If the instrument function has any sign of damage, do not use this monitor for any patient monitoring. Please contact the hospital's professional maintenance personnel or our customer service personnel.

All checks that require disassembling the instrument must be performed by qualified service personnel. Safety and maintenance checks may also be carried out by the Company's personnel.

16.2 Viewing software version information

You can view the software version through the following steps:

- Select  **【Settings】** Smart Hotkey→ “Settings” Menu;
- Select “Monitor Info>>”→ “Monitor Info” menu;
- “Monitor Info” menu displays the software version information of the monitor.

16.3 Maintenance plan

The following tasks can only be done by qualified service personnel of Bistos. When the following maintenance is needed, please contact your service representative. Before testing or maintenance, clean and disinfect the device.

Inspection / Maintenance Item	Frequency
Check the safety according to IEC 60601-1	At least once every two years, after replacing the power supply or the monitor falls down.
Check all monitoring or measuring functions not listed	At least once every two years, or when you suspect that the measured value is not accurate.
NIBP leakage test	At least once every two years, or follow hospital regulations
NIBP calibration	At least once every two years, or follow hospital regulations

16.4 ECG calibration

In the process of using the monitor, the displayed ECG signals may be inaccurate due to hardware or software problems, mainly shown as waveform amplitude becoming larger or smaller. At this moment, you need to calibrate ECG.

Prepare the following instruments before testing:

- ECG simulator
- ECG cable
- Vernier caliper

The calibration method is as follows:

- Connect the ECG cable to the monitor.
- Connect the ECG electrodes to the ECG simulator.
- Select  【Settings】 Smart Hotkey→ “Settings” Menu;
- Select “User Maintenance >>” →enter the password and confirm → “User Maintenance” menu.
- Select “Module Maintenance >>” → “Module Maintenance” menu.
- Select “ECG ”→ “ECG Maintenance” menu, and select “Calibration” to calibrate the ECG.
- Measure the wave amplitude with a caliper; in different filtering modes, ×0.25 is $2.5 \pm 5\%$ (mm), ×0.5 is $5.0 \pm 5\%$ (mm), ×1 is $10.0 \pm 5\%$ (mm), and ×2 is $20.0 \pm 5\%$ (mm). Comparing the amplitude of the square wave with the ruler, the error range should be within 5%.
- When calibration is complete, select “Stop Calibration” to exit.

17 Accessories

WARNING

- Use the accessories specified in this manual. Using other accessories may damage the monitor, or cannot reach the safety and performance claimed in this manual.
- The operating and storage environment of the monitor should meet the requirements of the accessories. Please refer to the manual of the accessories for these requirements.
- Disposable accessories can only be used once, because repeated use can cause performance degradation.
- If the packaging or accessories have any sign of damage, do not use such accessories.
- For ECG Cables, SpO₂ Sensor, Blood Pressure Cuff and Temperature Sensor, the normal life time is two years. Please replace in time.

Standard accessories are as follows:

No.	Description	QTY	Type-number
1	ECG Cables and lead-wires ECG electrodes(5)	1	Manufacturer: Shenzhen Launch Electronics Tech CO., Ltd
			98ME01AC009(AHA standard) or 98ME01EC009(IEC standard)
2	Adult Finger Clip SpO ₂ Sensor	1	Manufacturer: Unimed Medical Supplies,Inc
3	SpO ₂ extension cable		U403-01
4	Adult Non-Invasive blood pressure cuff	1	Manufacturer: Shenzhen Med-link Electronics Tech Co.,Ltd Y000A1
5	NIBP extension tube	1	Manufacturer: XIAMEN CONJOIN ELECTRONICS TECHNOLOGY CO., LTD
			CJP37-C12B1
6	Temperature Sensor	1	Manufacturer: Shenzhen taijia electronic Co., Ltd
			SPT4520010N
7	Power Adapter	1	Manufacturer: DONGGUAN SHILONG GUHUA ELECTRONIC CO., LTD
			UE36LCP1-150240SPA

18 Specifications

18.1 Safety specifications

18.1.1 Product category

In accordance with classification specified in the European Medical Device Directive 93/42/EEC, this monitor is Class IIb device. The monitor is classified as follows in accordance with IEC 60601-1:

Category Name	Specification
Type of electric shock protection	Class II and internally powered equipment When you question the integrity of the external protective earthing or protective ground conductor parameter of the equipment, the device must be powered by the internal power supply (battery).
Electric shock protection grade	Type CF applied part (defibrillation proof)
Explosion protection grade	Common equipment, no explosion protection
Liquid inlet protection grade	IPX1
Operating mode	Continuous mode
Movement	Portable equipment

18.1.2 Power

Power	
Adapter	Input: AC 100 - 240V (50/60 Hz) Output: DC 15V / 2.4A
Rechargeable Battery	11.1V Li-ion battery 4400 mA
	Operating Time(When it fully charged): 5 hours
	Charging Time(Fully): 4 hours

18.2 Hardware specifications

Physical Characteristics	
Dimensions	Main Unit: 320(W) X 250(H) X 65(D)
Weight	<= 2.8 Kg for standard configuration

Display	
Type	Color TFT touch screen LCD
Size and resolution	12", 800 X 600 pixels

Audio	
Speaker	Alarm sound (45 ~ 85 dB), key pressing sound
	QRS sound, PR sound
	Alarm sound meet the IEC 60601-1-8 standard requirements

Alarm signal	
Alarm delay	Off, 1s, 2s, 3s, 4s, 5s, 6s, 7s, 8s, depending on the setup Default is 4s
Pause duration	1min, 2min, 3min, 4min, 5min, 10min, 15min or permanent, depending on the setup Default is 2 minutes.

Data storage	
Trend	168 hours. Resolution: 1 min
Alarm event	200 physiological alarm events, 100 technical alarm events
NIBP measurement result	1000 groups

Environment		
	Operation	Transport and storage
Temperature	5~ 40°C (41°F~104°F)	-20 ~ 60°C (-4°F~140°F)
Humidity	30~ 85% non-condensing	0 ~ 95 % non-condensing
Atmospheric pressure	70~106 kPa	70~106 kPa

18.3 Functional specifications

18.3.1 ECG/TEMP/RESP

ECG		
Lead Type	3 lead	I, II, III
	5 lead	I, II, III, aVR, aVL, aVF, V
Display sensitivity	Auto, 2.5mm/mV(x0.25), 5 mm/mV(x0.5), 10mm/mV(x1.0), 20mm/mV(x2.0), 40mm/mV(x4.0)	
Wave sweep speed	12.5 mm/s, 25 mm/s, 50 mm/s	
Band width	Diagnostic mode	0.05 - 100 Hz
	Monitor mode	0.5 - 40 Hz
	Surgery mode	1 - 25 Hz
CMRR	>100 dB	
Notch	50/60 Hz notch filter can be set to on or off	
Differential input impedance	> 5 MΩ	
Electrode polarization voltage range	± 400 mV	
Baseline recovery time	<5s after defibrillation (in monitor and surgery mode)	
Calibration signal	1 mV (peak – peak), accuracy ± 3%	
Lead-off detection current	Measuring electrode: < 0.1 uA Drive electrode: < 1uA	

Pacing pulse	
Pulse identification	For PACE MAKER pulses that meet the criteria below, pacing pulse will be marked on the screen. Detection range(Amplitude): ± 2 mV ~ ± 700 mV Pulse width: 0.2ms ~ 2.0 ms
Average HR	Calculate from 15s data
Interval of HR refreshing	Calculate once every second
HR change response time	Time from 80 bpm to 120 bpm: ≤ 10 sec Time from 80 bpm to 40 bpm: ≤ 10 sec
Tall T-wave suppression	For T-wave with 100ms QRS wave, 350ms QT period, 180ms duration and 1.2mV amplitude, the HR calculation will not be affected
Without overshoot rejection of pacemaker pulses	Amplitudes (ap) from ±2 mV to ±700 mV and pulse widths from 0.1 ms to 2.0 ms.
Tall T-wave rejection capability	2mV

HR		
Measuring range	Adult: 15 ~ 300 bpm Pediatric: 15 ~ 350 bpm	
Resolution	1 bpm	
Heart rate measurement error	± 1 bpm or $\pm 1\%$, whichever is greater	
Heart rate measuring accuracy and response to irregular rhythm	Ventricular bigeminy	80 ± 1 bpm
	Slow alternating ventricular bigeminy	60 ± 1 bpm
	Rapid alternating ventricular bigeminy	120 ± 1 bpm
	Bidirectional systoles	90 ± 2 bpm
Time to alarm for tachycardia	1 mV, 206 bpm Ventricular tachycardia	<10 s
	0.5 mV, 206 bpm Ventricular tachycardia	<10 s
	2 mV, 206 bpm Ventricular tachycardia	<10 s
	2 mV, 195 bpm Ventricular tachycardia	<5 s
	1 mV, 195 bpm Ventricular tachycardia	<5 s
	4 mV, 195 bpm Ventricular tachycardia	<5 s

HR Alarm	
HR upper limit	Adult: 16 ~ 300, 1 bpm step Pediatric: 16 ~ 350, 1 bpm step
HR lower limit	Adult: 15 ~ 299, 1 bpm step Pediatric: 15 ~ 349, 1 bpm step

TEMP	
Standard compliance	ISO 80601-2-56:2009
Measurement method	Thermistor
Operating mode	Direct mode
Measuring range	0 °C ~ 50.0 °C (32 °F ~ 122.0 °F)
Resolution	0.1 °C
Measurement accuracy	± 0.3 °C
Number of channel	2

TEMP Alarm	
T1/T2 upper limit	0.1 °C ~ 50.0 °C, 0.1 °C/°F step
T1/T2 lower limit	0 °C ~ 49.9 °C, 0.1 °C/°F step
TD upper limit	0 °C ~ 50.0 °C, 0.1 °C/°F step

RESP	
Measurement method	Thoracic electrical bio impedance method
Measuring range	Lead RA-LA, RA-LL, LA-RL, LL-RL
Wave gain	X0.5, x1, x2
Respiratory impedance range	0.2 ~ 3 Ω
Base line impedance	500 ~ 2 000 Ω
Scan speed	6.25 mm/s, 12.5 mm/s, 25 mm/s
Measurement accuracy	± 2 rpm
Measurement range	0 ~ 120 rpm

RR Alarm	
RR upper limit	Adult: 7 ~ 120 Pediatric: 7 ~ 150
RR lower limit	Adult: 6 ~ 119 Pediatric: 6 ~ 149

18.3.2 NIBP

NIBP			
Standards compliant	IEC 80601-2-30:2009/A1:2013		
Measurement method	Automatic oscillometric method		
Operating mode	Manual, automatic, continuous		
Useful life	100,000 times		
Measurement interval in automatic mode	1/2/3/4/5/10/15/30/60/90/120/180/240/480min		
Typical measurement time	20~40s		
Normal mode measuring range (mmHg)		Adult	Pediatric
	Systolic blood pressure	40-270	40-200
	Mean blood pressure	20-230	20-175
	Diastolic blood pressure	10-210	10-162
Measurement accuracy	Maximum average error: ± 5 mmHg Maximum standard deviation: 8mmHg		
Resolution	1mmHg		
Initial inflation pressure		Default	Pressure setting range
	Adult	160mmHg	140mmHg, 160mmHg, 180mmHg
	Pediatric	140mmHg	140mmHg, 160mmHg,
Overpressure protection point (software)	Adult: 300mmHg		
	Pediatric: 240mmHg		
Overpressure protection point (hardware)	Adult: 320~330mmHg		
	Pediatric: 265~275mmHg		
Static Pressure accuracy	± 3 mmHg		

NIBP Alarm			
		Adult	Pediatric
NIBP upper limit (mmHg) 1 mmHg step	SYS	31 ~ 280	31 ~ 230
	MAP	11 ~ 240	11 ~ 175
	DIA	11 ~ 220	11 ~ 165
NIBP lower limit (mmHg) 1 mmHg step	SYS	30 ~ 279	30 ~ 229
	MAP	10 ~ 239	10 ~ 174
	DIA	10 ~ 219	10 ~ 164

NIBP Electrical characteristics	
Supply voltage	10V~14V DC
Maximum power consumption	3.6w
Quiescent current	50mA
Maximum current during measurement	180mA
Maximum current during inflation	300mA

18.3.3 SpO₂

SpO₂		
Standards compliant	ISO 80601-2-61:2011	
Measurement accuracy verification		
<p>The SpO₂ accuracy has been verified in human experiments by Comparing with arterial blood sample reference measured with a CO-oximeter. Pulse oximeter measurements are statistically distributed and about two-thirds of the measurements are expected to come within the specified accuracy range compared to CO- oximeter measurements.</p> <p>The accuracy of the oximeter has been validated by a clinical trial involving 12 healthy adult subjects - 4 women and 8 men. Among them medium skin are 4 subjects, light skin are 5 subjects, dark skin are 3 subjects, the age from 21 to 28.</p> <p>Overall accuracy was determined by calculating the root mean square error across all samples and is 1.56%".</p>		
Display range	0% ~ 100%	
SpO ₂ display resolution	1%	
SaO ₂ checking accuracy	±2% (70%~100%); not define when lower than 70% ;	
SpO ₂ alarm limit range	Upper alarm limit	1%~100%
	Lower alarm limit	0%~99%
SpO ₂ alerting signal generates a delay	No delay	
SpO ₂ value refresh period	1s/time	
Average period	Low sensitivity	6 ~ 8s
	Intermediate sensitivity	4 ~ 6s
	Advanced sensitivity	2 ~ 4s
Alarm condition delay period	Low sensitivity	< 8s
	Intermediate sensitivity	< 6s
	Advanced sensitivity	< 4s
Alarm sign generates delay period	0s	

PR	
Measuring range	25~250bpm
Resolution	1% bpm
Accuracy	±2% or ±2bpm, whichever is greater

PR alarm	
Upper limit	Adult: 16 ~ 300 Pediatric: 16 ~ 350
Lower limit	Adult: 15 ~ 299 Pediatric: 15 ~ 349

19 Alarm information

This chapter lists some important physiological and technical alarm information, and some alarms are not necessarily listed.

Note that in this chapter: P column indicates the default alarm priority: H indicates high priority, M indicates middle priority, L indicates low priority, and “*” indicates priority set by the user.

Corresponding countermeasures are listed for each alarm message. If you operate in accordance with the countermeasures but the problem persists, contact your service personnel.

19.1 Physiological alarms

Source	Alarm message	P	Causes and countermeasures
ECG	HR Too High	M*	HR value is higher than the upper alarm limit or lower than the lower alarm limit. Check the patient's physiological condition, and check if the patient category and alarm limit settings are appropriate for the patient.
	HR Too Low		
	PVCS Too High	M*	PVCs value is higher than the upper alarm limit or lower than the lower alarm limit. Check the patient's physiological condition, and check if the patient category and alarm limit settings are appropriate for the patient.
	Asystole	H	The patient has arrhythmia. Check the patient's condition, electrodes, cables and lead wires.
	VF/VTA	H	
	R on T	M*	
	Frequent PVC	M*	
	Couplet PVC	M*	
	Single PVC	M*	
	PVC Bigeminy	M*	
	PVC Trigeminy	M*	
	Tachycardia	M*	
	Bradycardia	M*	
	Miss Beat	M*	
	Pacemaker Not Capture	H	Pacemaker works abnormally; check the pacemaker.
	Pacemaker Not work	H	
	ECG Signal weak	H	The patient ECG signal is too weak, and the system can't analyze. Check the patient's condition, electrodes, cables and leads.
	ST-I Too High	M*	ST value is higher than the upper alarm limit or
ST-I Too Low			

Source	Alarm message	P	Causes and countermeasures
	ST-II Too High		lower than the lower alarm limit. Check the patient's physiological condition, and check if the patient category and alarm limit settings are appropriate for the patient.
	ST-II Too Low		
	ST-III Too High		
	ST-III Too Low		
Resp	RR Too High	M*	Patient PR value is higher than the upper alarm limit or lower than the lower alarm limit. Check the patient's physiological condition, and check if the patient category and alarm limit settings are appropriate for the patient.
	RR Too Low		
	Apnea(RESPI)	H	The patient's respiratory signal is too weak, and the system can't analyze. Check the patient's condition, electrodes, cables and leads.
	RESP ARTIFACT	H*	Respiration heartbeat interference
Temp	T1 Too High	M*	T1/T2 value is higher than the upper alarm limit or lower than the lower alarm limit. Check the patient's physiological condition, and check if the patient category and alarm limit settings are appropriate for the patient.
	T1 Too Low		
	T2 Too High		
	T2 Too Low		
	TD Too High		TD value is higher than the upper alarm limit or lower than the lower alarm limit. Check the patient's physiological condition, and check if the patient category and alarm limit settings are appropriate for the patient.
SpO ₂	SpO ₂ Too High	M*	SpO ₂ value is higher than the upper alarm limit or lower than the lower alarm limit. Check the patient's physiological condition, and check if the patient category and alarm limit settings are appropriate for the patient.
	SpO ₂ Too Low		
	PR Too High		PR value is higher than the upper alarm limit or lower than the lower alarm limit. Check the patient's physiological condition, and check if the patient category and alarm limit settings are appropriate for the patient.
	PR Too Low		
NIBP	NIBP signal weak	M*	NIBP value is higher than the upper alarm limit or lower than the lower alarm limit. Check the patient's physiological condition, and check if the patient category and alarm limit settings are appropriate for the patient.
	NIBP-Sys Too High		
	NIBP-Sys Too Low		
	NIBP-Mean Too High		
	NIBP-Mean Too Low		
	NIBP-Dia Too High		

19.2 Technical alarms

Source	Alarm message	P	Causes and countermeasures	
System	Battery Low	H	Connect to AC power supply, and charge the battery, and power with the battery as needed after fully charged.	
ECG	ECG Comm. Stop	H	ECG module failure, or communication failure between the module and the host; please restart the device.	
	ECG Comm. Error	H		
	ECG Config Error	H		
	ECG Selfcheck Error	H		
	ECG Lead Off	M*	The electrodes are not connected to the patient firmly or fall off, or lead wires and the main cable fall off. Check the connection of electrodes and lead wires.	
ECG YY OFF (YY is a lead name)	M*			
Temp	TEMP1 Sensor Off	L	The temperature sensor falls off from the patient. Check the sensor connection.	
	TEMP2 Sensor Off	L		
SpO ₂	SpO ₂ Comm. Stop	H	SpO ₂ module failure, or communication failure between the module and the host; please restart the device.	
	SpO ₂ Comm. Error	H		
	SpO ₂ No Sensor	L	SpO ₂ sensor falls off from the patient or monitor, malfunctions, or sensor other than specified in this Manual is used. Check the sensor mounting position, whether the sensor is damaged or sensor type. Reconnect the sensor or use new sensor.	
	SpO ₂ Sensor Off	L		
	SpO ₂ Search Timeout	L		
	SpO ₂ Search Pulse	L	Sensor signal is poor or too weak. Check the patient's condition, and place the sensor in a suitable position. If the failure persists, replace the sensor.	
NIBP	NIBP Comm. Stop	H	NIBP module failure, or communication failure between the module and the host; please restart the device.	
	NIBP Comm. Error	H		
	NIBP Selfcheck error	H		
	NIBP CFG Error	H		
		NIBP system error	H	If failure occurs during measurement, the system can't analyze and calculate. Check the patient's condition, check the connections or replace the cuff, and then re-test.
		Measurement timeout	L	
	Cuff type error	L	The used cuff does not match the set patient category. Verify the patient category and replace the cuff.	
NIBP	Cuff loose or no cuff	L	NIBP cuff isn't placed or connected properly, or there is gas leak.	
	Cuff leak	L	Check cuff and inflation tube.	
	Air pressure error	L	Ambient atmospheric pressure is abnormal. Confirm that the environment complies with the	

Source	Alarm message	P	Causes and countermeasures
			monitor's specifications, and check whether there are special reasons affecting ambient pressure.
	NIBP over range	L	The measured blood pressure of the patient exceeds the measuring range.
	NIBP signal weak	L	Patient's pulse may be weak or cuff is too loose. Check the condition of the patient, and place the cuff in a suitable position. If the failure persists, replace the cuff.
	NIBP signal unstable	L	Excessive movement may result in too much motion artifact or interference in the signal during measurement.
	NIBP signal saturated	L	Motion signal amplitude is too large due to movement and other reasons.
	NIBP over pressure	L	Cuff overpressure, and gas blockage may occur; check the gas path, and then re-measure.
	Module reset failed	L	NIBP module reset error; check the gas path is blocked, and then restart the measurement.

20 Default parameter configuration

This chapter lists the important factory default settings of different departments in monitor configuration mode. Users can not change the default configuration, but can modify the settings as required and save as user-defined configuration.

Module	Option		Module defaults		
			Adult	Pediatric	
ECG	Alarm level		Mid	Mid	
	Alarm record		Off	Off	
	Lead type		5-lead	5-lead	
	Calculation channel		Auto	Auto	
	Power frequency suppression		On	On	
	Alarm limits		50~120 on	75~160 on	
	ST segment analysis	ST segment analysis		Off	Off
		Alarm level		Mid	Mid
		Alarm record		Off	Off
		Alarm limits		-0.2~0.2 on	-0.2~0.2 on
	Arrhythmia analysis	Alarm level		Mid	Mid
		Alarm record		Off	Off
		Alarm limits		0~10 on	0~10 on
		ARR alarm settings	Alarm switch	On	On
	Alarm level		Mid	Mid	
	Alarm record		Off	Off	
	Gain		x1	x1	
Wave velocity		25.0mm/s	25.0mm/s		
Filter mode		Monitor	Monitor		
Wave color		Green	Green		
Wave style		Color scale	Color scale		
NIBP	Alarm level		Mid	Mid	
	Alarm record		Off	Off	
	Pressure unit		mmHg	mmHg	
	Measurement mode		Adult	Pediatric	
	Interval		Manual	Manual	
	Display color		White	White	
	Pre-inflation value		150	100	
	Systolic blood pressure limit		90~160 on	70~120 on	
	Mean blood pressure limit		60~110 on	50~90 on	
Diastolic blood pressure limit		50~90 on	40~70 on		
SpO ₂	Alarm level		Mid	Mid	
	Alarm record		Off	Off	
	Alarm limits		90~100 on	90~100 on	
	Wave velocity		25.0	25.0	
	Wave color		Cyan	Cyan	
	Wave style		Line	Line	
RESP	Alarm level		Mid	Mid	
	Alarm record		Off	Off	
	Apnea alarm		20 sec	20 sec	

Module	Option	Module defaults	
		Adult	Pediatric
	Alarm limits	8~30 on	8~30 on
	Gain	x1	x1
	Wave velocity	12.5	12.5
	Wave color	Yellow	Yellow
	Wave style	Line	Line
PR	Alarm source	SpO ₂	SpO ₂
	Alarm level	Mid	Mid
	Alarm record	Off	Off
	Alarm limits	50~120 on	75~160 on
TEMP	Alarm level	Mid	Mid
	Alarm record	Off	Off
	Display color	White	White
	Temperature unit	°C	°C
	T1 alarm limits	36.0~39.0 on	36.0~39.0 on
	T2 alarm limits	36.0~39.0 on	36.0~39.0 on
	TD alarm limits	0.0~2.0 on	0.0~2.0 on

21 Common faults and maintenance

The following table shows the common faults on the operation, and the solution.

Faults	Solution
Blank Screen	Connects the monitor to check the screen and screen line whether normal.
The system time is not correct	<ol style="list-style-type: none"> 1. Set up error, can be reset through the system User Maintenance menu. 2. The button battery on main control board is run out, please change the button battery.
No ECG waveform	<ol style="list-style-type: none"> 1. See the ECG cable and lead-wires whether in good condition, disconnected or electrode rusting result in connection fail. 2. Look at whether the ECG cable and lead type are consistent.
Unable to do ST analysis	<ol style="list-style-type: none"> 1. Check the ECG Setup→ ST Analysis→ ST Analysis is set to "On". 2. Check the ECG Setup→ Other Setup→ Paced whether be set to "On". If Paced is set to "On", means the patient have a pacemaker; in this case the machine is not doing the ST analysis.
No SpO ₂ waveform or value	Check whether the SPO2 Sensor is connected and in good condition.
Blood pressure does not start	<ol style="list-style-type: none"> 1. Check whether the pump is broken. 2. Check whether the trachea is broken. 3. Check whether the blood pressure plate is normal.
Blood pressure started, but couldn't measure the value	<ol style="list-style-type: none"> 1. Check whether the blood pressure cuff is leakage. 2. Check whether the NIBP extension tube and machine connect is well. 3. Check whether the deflating valve on blood pressure plate is normal. 4. Check whether the pressure sensor is normal.

If the above doesn't solve the problem, please contact Bistos after-sales department or dealers.

22 Manufacturer's declaration on EMC

BT-770 needs special precautions regarding EMC (Electromagnetic compatibility) and needs to be used according to the EMC information provided in this user manual. Wireless communications equipment such as wireless home network devices, mobile phones, cordless telephones and their base stations, walkie-talkies can affect the BT-770 and should be kept at least 1 m away from the equipment.

NOTE

- Using unqualified accessories, sensors and cables will increase the electromagnetic emission and reduce the electromagnetic immunity of the device.
 - Do not put the device close to other devices or stack together. When necessary, observe the device closely to ensure that it runs normally in the environment.
 - The device requires special EMC protection, and it is necessary to install and maintain it in the environment that meets the following EMC information.
 - Even if other devices comply with CISPR emission requirements, they may also cause interference to this device.
 - When the input signal amplitude is smaller than the minimum amplitude specified in the technical specifications, it may result in inaccurate measurements.
 - Mobile communication devices or wireless network devices may have an impact on the device.
-

22.1 Electromagnetic emissions

The BT-770 is intended for use in the electromagnetic environment specified below.
The customer or the user of the BT-770 should assure that it is used in such an environment.

Emissions test	Compliance	Electromagnetic environment - guidance
RF emissions CISPR 11	Group 1	The BT-770 uses RF energy only for its internal function. Therefore, its RF emissions are very low and are not likely to cause any interference in nearby electronic equipment.
RF emissions CISPR 11	Class A	The BT-770 is suitable for use in all establishments other than domestic, and may be used in domestic establishments and those directly connected to the public low-voltage power supply network that supplies buildings used for domestic purposes, provided the following warning is heeded: Warning: This BT-770 is intended for use by healthcare professionals only. This equipment/ system may cause radio interference or may disrupt the operation of nearby equipment. It may be necessary to take mitigation measures, such as re-orienting or relocating the BT-770 or shielding the location.
Harmonic emissions IEC 61000-3-2	Class A	
Voltage fluctuations / flicker emissions IEC 61000-3-3	Complies	

22.2 Recommended separation distances between portable and mobile RF communications equipment and BT-770

The BT-770 is intended for use in an electromagnetic environment in which radiated RF disturbances are controlled. The customer or the user of the BT-770 can help prevent electromagnetic interference by maintaining a minimum distance between portable and mobile RF communications equipment (transmitters) and the BT-770 as recommended below, according to the maximum output power of the communications equipment.

Rated maximum output power of transmitter [W]	Separation distance according to frequency of transmitter [m]		
	150 kHz to 80 MHz $d = 3.5\sqrt{p}$	80 MHz to 800 MHz $d = 3.5\sqrt{p}$	800 MHz to 2.5 GHz $d = \left[\frac{7}{3}\right]\sqrt{p}$
0.01	0.35	0.35	0.23
0.1	1.11	1.11	0.74
1	3.5	3.5	2.34
10	11.07	11.07	7.38
100	35	35	23.24

For transmitters rated at a maximum output power not listed above, the recommended separation distance d in meters (m) can be estimated using the equation applicable to the frequency of the transmitter, where P is the maximum output power rating of the transmitter in watts (W) according to the transmitter manufacturer.

NOTE 1) At 80 MHz and 800 MHz, the separation distance for the higher frequency range applies.

NOTE 2) These guidelines may not apply in all situations. Electromagnetic propagation is affected by absorption and reflection from structures, objects and people.

22.3 Electromagnetic immunity

The BT-770 is intended for use in the electromagnetic environment specified below. The customer or the user of the BT-770 should assure that it is used in such an environment.

Immunity test	IEC 60601 Test level	Compliance level	Electromagnetic environment -guidance
Electrostatic discharge (ESD) IEC 61000-4-2:2009	±8 kV Contact ±15 kV air	±8 kV Contact ±15 kV air	Floors should be wood, concrete or ceramic tile. If floors are covered with synthetic material, the relative humidity should be at least 30 %.
Electrical fast transient/burst IEC 61000-4-4:2004	±2 kV for power supply lines ±1 kV for input/output lines (>3m)	±2 kV for power supply lines ±1 kV for input/output lines (>3m)	Mains power quality should be that of a typical commercial or hospital environment.
Surge IEC 61000-4-5:2006	±1 kV differential mode ±2 kV common mode	±1 kV differential mode ±2 kV common mode	Mains power quality should be that of a typical commercial or hospital environment.
Voltage dips, short interruptions and voltage variations on power supply input lines IEC 61000-4-11:2004	< 5 % U_T (> 95 % dip in U_T) for 0.5 cycles 40 % U_T (60 % dip in U_T) for 5 cycles 70 % U_T (30 % dip in U_T) for 25 cycles <5 % U_T (> 95 % dip in U_T) for 5 s	< 5 % U_T (> 95 % dip in U_T) for 0.5 cycle 40 % U_T (60 % dip in U_T) for 5 cycles 70 % U_T (30 % dip in U_T) for 25 cycles <5 % U_T (> 95 % dip in U_T) for 5 s	Mains power quality should be that of a typical commercial or hospital environment. If the user of the BT-770 requires continued operation during power mains interruptions, it is recommended that the BT-770 be powered from an uninterruptible power supply.
Power frequency (50 Hz and 60 Hz) magnetic field IEC 61000-4-8:2010	3 A/m	3 A/m	Power frequency magnetic fields should be at levels characteristic of a typical location in a typical commercial or hospital environment.

NOTE U_T is the a.c. mains voltage prior to application of the test level.

The BT-770 is intended for use in the electromagnetic environment specified below. The customer or the user of the BT-770 should assure that it is used in such an environment.

Immunity test	IEC 60601 test level	Compliance level
Conducted RF IEC 61000-4-6:2009	3 Vrms 150 kHz to 80 MHz	3 Vrms
Radiated RF IEC 61000-4-3	3 V/m 80 MHz to 2.5 GHz	3 V/m

Electromagnetic environment - guidance

Portable mobile RF communications equipment should be used no closer to any part of the BT-770, including cables, than the recommended separation distance calculated from the equation applicable to the frequency of the transmitter.

Recommended separation distance

$$d - 1.2\sqrt{p} \quad (d - 3.5\sqrt{p})$$

$$d - 1.2\sqrt{p} \quad (\text{Resp: } d - 3.5\sqrt{p}) \quad 80 \text{ to } 800\text{MHz}$$

$$d - 1.2\sqrt{p} \quad 800\text{M to } 2.5\text{GHz}$$

where P is the maximum output power rating of the transmitter in watts (W) according to the transmitter manufacturer and d is the recommended separation distance in meters (m).

Field strengths from fixed RF transmitters, as determined by an electromagnetic site survey^a, should be less than the compliance level in each frequency range.^b

Interference may occur in the vicinity of equipment marked with the following symbol :



NOTE 1) At 80 MHz and 800 MHz, the higher frequency range applies.

NOTE 2) These guidelines may not apply in all situations. Electromagnetic propagation is affected by absorption and reflection from structures, objects and people.

^a Field strengths from fixed transmitters, such as base stations for radio (cellular/cordless) telephones and land mobile radios, amateur radio, AM and FM radio broadcast and TV broadcast cannot be predicted theoretically with accuracy. To assess the electromagnetic environment due to fixed RF transmitters, an electromagnetic site survey should be considered. If the measured field strength in the location in which the BT-770 is used exceeds the applicable RF compliance level above, the BT-770 should be observed to verify normal operation. If abnormal performance is observed, additional measures may be necessary, such as re-orienting or relocating the BT-770.

^b Over the frequency range 150 kHz to 80MHz, field strengths should be less than 3 V/m.

Product Warranty

Product Name	Patient Monitor
Model Name	BT-770
Serial No.	
Warranty Period	2 Years
Date of Purchase	
Customer	Hospital: Address: Name: Telephone:
Sales Agency	
Manufacture	Bistos Co., Ltd.

- ※ Thank you for purchasing BT-770.
- ※ This product is manufactured and passed through strict quality control and inspection.
- ※ Compensation standard concerning repair, replacement, refund of the product complies with “**Framework Act on Consumers**” noticed by Fair Trade Commission of Republic of Korea.

Service Telephone and Fax. Numbers

Telephone: +82 31 750 0340

Fax: +82 31 750 0344



Bistos Co., Ltd.

7th FL., A Bldg., Woolim Lions Valley 5-cha, 302,
Galmachi-ro, Jungwon-gu, Seongnam-si,
Gyeonggi-do, Korea

www.bistos.co.kr
bistos@bistos.co.kr

EC REP Obelis s.a

Bd. Général Wahis 53 1030 Brussels / BELGIUM

Telephone: +32 2. 732.59.54

Fax: +49 2. 732.60.03