

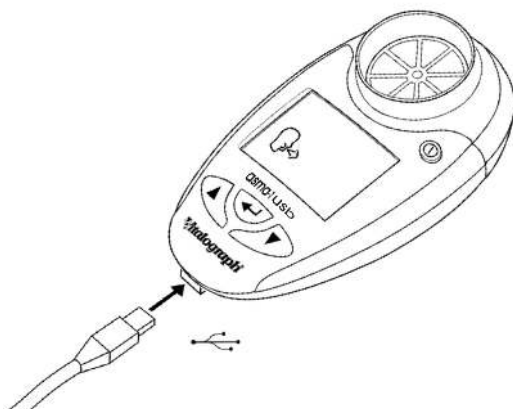

# asma-1 USB

MODEL 4000



## Instructions for Use

© Copyright Vitalograph 2020 Current Edition (Issue 1, 28-Jan-2020) Cat. No. 09720

---

## Vitalograph Branch Addresses

### Vitalograph Ltd, UK

Maids Moreton, Buckingham  
MK18 1SW  
England

**Tel:** 01280 827110

**Fax:** 01280 823302

**E-mail:** sales@vitalograph.co.uk

www.vitalograph.co.uk

*Technical Support*

**Tel:** 01280 827177

**Email:** tech.support@vitalograph.co.uk

### Vitalograph Ltd, International

Maids Moreton, Buckingham  
MK18 1SW  
England

**Tel:** +44 1280 827120

**Fax:** +44 1280 823302

**E-mail:** sales@vitalograph.co.uk

www.vitalograph.eu

*Technical Support*

**Tel:** +353 65 6864111

**Email:** technical.support@vitalograph.ie

### Vitalograph GmbH

Rellinger Straße 64a  
D-20257 Hamburg  
Germany

**Tel:** +49 40 547391-40

**Fax:** +49 40 547391-40

**E-mail:** info@vitalograph.de

www.vitalograph.de

*Technical Support*

**Telefon:** +49 40 547391-14

**E-mail:** support@vitalograph.de

### Vitalograph Inc.

13310 West 99th Street  
Lenexa, Kansas, 66215  
USA

**Toll Free:** 800 255 6626

**Tel:** (913) 730 3200

**Fax:** (913) 730 3232

**E-mail:** contact@vitalograph.com

www.vitalograph.com

*Technical Support*

**Tel:** (913) 730-3205

**Email:** technical@vitalograph.com



### Vitalograph (Ireland) Ltd

Gort Road Business Park  
Ennis, Co Clare, V95 HFT4  
Ireland

**Tel:** +353 65 6864100

**Fax:** +353 65 6829289

**E-mail:** sales@vitalograph.ie

www.vitalograph.ie

*Technical Support*

**Tel:** +353 65 6864111

**Email:** technical.support@vitalograph.ie

### Vitalograph Ltd, Hong Kong/China

P.O. Box 812  
Shatin Central Post Office  
Hong Kong

**E-mail:** sales@vitalograph.cn

www.vitalograph.cn

*Technical Support*

**Tel:** +353 65 6864111

**Email:** technical.support@vitalograph.ie

© Copyright Vitalograph 2020  
Current Edition (Issue 1, 28-Jan-2020)  
Cat. No. 09720

 **Vitalograph** is a registered trademark.

DT\_0006 Issue 15

## 1. Main Components of the Vitalograph asma-1 USB

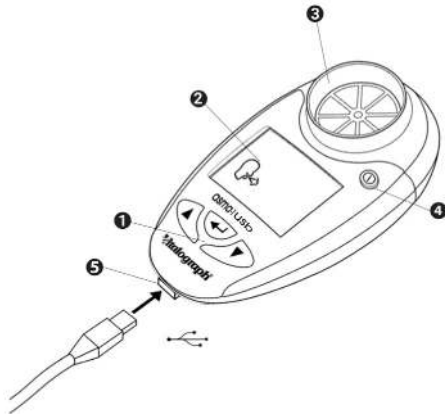

Figure 1 Vitalograph asma-1 USB Components

1	User Buttons
2	Display
3	Flowhead
4	On / Off button
5	USB
▼	Down Button
▲	Up Button
↵	Enter Button

### 1.1. Features of the Vitalograph asma-1 USB

- Electronic records
- Stores 600 test sessions
- Download test results via USB and export to PDF report using Vitalograph Reports software.
- Automatically assesses test quality
- Measures PEF and FEV1 and % of personal best
- PEF and FEV1 zones can be personalized
- Automatically stores best values

## 2. Setting Up the Vitalograph asma-1 USB

To get the Vitalograph asma-1 USB ready for use:

1. Remove the detachable battery door at rear of unit. Fit two AAA 1.5V batteries. Replace battery door.
2. Attach a mouthpiece to the flowhead.



Figure 2. Mouthpiece inserted into flowhead

3. If used for multiple subjects, Vitalograph intends that a new Eco Bacterial Viral Filter (Eco BVF) be used for every test subject to prevent cross contamination. Using a new Eco BVF provides a significant level of protection of the subject, the device and the user against the risk of cross contamination during spirometry manoeuvres. Eco BVF and SafeTway mouthpieces are single use items and must be disposed of after use.
4. Turn on via the  On/Off Button. (The same button is used to power down.)











### 3. Operating Instructions

If the device has just been unpacked or transported, ensure that it is left sitting, fully powered and is at room temperature prior to testing.

#### 3.1. Setting Personal Best (Reference) Values

Personal Best (reference) values can be set for peak flow (PEF) and/or forced expiratory volume after 1 second (FEV1).

To set the Personal Best (reference) PEFs:

1. Turn the device on, .
2. When the device is ready for a test () , press the  and  buttons together for 3 seconds.
3. Set the reference PEF value by pressing the  button and releasing when the value is reached. Press the  to roll back. The values will increase/decrease in values of 10. If the button is kept depressed, the values will scroll faster.
4. Press ENTER  to save the reference PEF value.
5. Press  to exit, OR to set the Best Test (reference) FEV1:
6. Set the reference FEV1 value by pressing the  button and releasing when the value is reached. Press the  to roll back. The values will increase/decrease in values of 0.10. If the button is kept depressed, the values will scroll faster.
7. Press ENTER  to save the reference FEV1 value. The device will return to the test screen.











**Note:** to de-activate zones, set both the PEF and FEV1 reference values to 000/0.00.

### 3.2. Setting Management Zones

The asma-1 USB can be set for use with 3 or 4 zone management plans. The zones are factory set to 2 boundaries (80% & 50%) resulting in 3 Zones (0-50%, 50-80%, 80-100%). For 4 zones the middle boundary is set last. The colour systems for each zone are:

Top Boundary	Green	Green	Top Boundary
	Yellow	Yellow	Middle Boundary
Bottom Boundary	Red	Orange	
	Red	Red	Bottom Boundary
	3 Zone	4 Zone	

To set boundary percentage values for 3 zones:

1. Turn the device on, .
2. When the device is ready for a test () , press the  and  buttons together for approximately 3 seconds.
3. Set the top (Green/Yellow) boundary by pressing the  or  button and releasing when the value is reached. The values will increase/decrease in values of 1%. If the button is kept depressed, the values will scroll faster.
4. Press ENTER  to save the boundary value.
5. Set the bottom (Yellow/Red) boundary by pressing the  or  button and releasing when the value is reached.
6. Press  to save the boundary value.
7. Select the next value as 0% (default). Only 2 boundaries are required for the 3 zone system.
8. Press . The device will return to the test screen.



To set the boundary percentage values for 4 zones:

1. Set the top and bottom boundaries – see steps 1 – 6 above.
2. Set the middle (Yellow/Orange) boundary by pressing the  button and releasing when the middle boundary value is reached. The values will increase/decrease in values of 1% after an initial jump to the lower boundary value. If the button is kept depressed, the values will scroll faster. This

boundary value cannot be set at a value that is greater than the top boundary value or less than the bottom boundary value.

3. Press  to save the middle (Yellow/Orange) boundary value. The device will return to the test screen.

### 3.3. Performing a Test

1. Fit a mouthpiece, SafeTway or Eco BVF filter to the device.
2. Turn the device on. 
3. Sit down to blow into the device (unless the physician advises otherwise).
4. When the device is ready for a test () , holding the head high, breathe in as deeply as possible, hold the Vitalograph asma-1 USB ready in front of the mouth, see Figure 3.

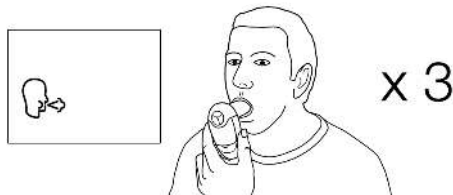



Figure 3. Holding device during test.

5. Holding the breath, place the mouthpiece into the mouth, biting the mouthpiece lightly, and with the lips firmly sealed around it.
6. Blow out as HARD and as FAST as possible for a second or more. Be careful not to block the mouthpiece with the tongue or teeth. A 'spitting' action will give false readings.
7. The PEF result for this blow displays on screen, followed by the FEV1 result after approximately 3 seconds. If the Personal Best has been set, an arrow indicates which colour management zone the blow relates to.
8. When the blow icon shows, blow again (). Usually 3 blows are required.
9. To view the best test in the session (best PEF and best

FEV1), press the  button. This value is recorded as the result for the session in the device history.





**Note:** An exclamation mark ! indicates a poor quality blow and the blow should be repeated.

The ! warning appears when the time to Peak Flow > 120ms or a cough is detected in the first second.

If dizziness or fatigue is experienced during the test session, wait until this passes before blowing again, or terminate the session.

### 3.4. Reviewing Previous Results



The asma-1 USB can store up to 600 test sessions. To view previously performed test sessions:

1. When the device is ready for a test () , press the  button for approximately 3 seconds.
2. The most recent test session displays. The best PEF result will be displayed for approximately 3 seconds, followed by the best FEV1 result. The session number '1' is also displayed, this is the latest session.
3. View earlier test sessions by pressing the  button.
4. Press . The device will return to the test screen.

### 3.5. Deleting All Results History

**Caution:** Results history cannot be recovered once it has been deleted.

To delete entire history, i.e. all previously stored session results:

1. When the device is ready for a test () , press the  and  buttons simultaneously for approximately 10 seconds.
2. A long beep indicates success. The device returns to the test screen.

### 3.6. Downloading saved results

The test session may be transmitted to Vitalograph Reports software on your PC where it can be stored as a PDF file and viewed or printed.

Vitalograph Reports must be installed and running on the PC before data is transmitted. The software is running if the Vitalograph 'V'



icon shows in the PC System Tray. If not, refer to help button of the software for more information. The USB cable should be attached to the device and also to the host PC to allow communication, see Figure 4. Drivers should automatically install.

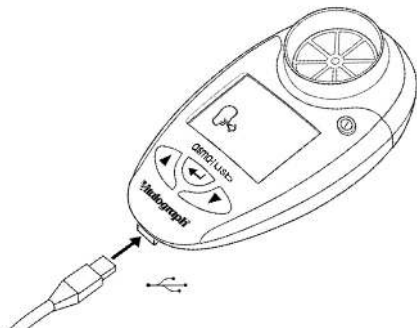









Figure 4. Attached USB cable.

1. Run Vitalograph Reports.
2. If the 'No devices have been detected' message appears, click 'Continue'.
  1. Turn on Device via the  On/Off Button
  2. In Vitalograph Reports ensure 'Vitalograph asma-1' is selected as the device via the Device Selection



Button

3. To print the test results from the asma-1 USB:
  1. When the device is ready for a test () , press the  button for 3 seconds. The device will show the Report icon (). OR
  2. After completing the test session, press the  or  button until the Report icon () is displayed. Press .

4. Once the print icon is displayed on the device, start the service as shown by selecting 'Start Report Service' from the 'File' Menu
5. Vitalograph Reports will download the report and the report will be generated.
6. In Vitalograph Reports enter the Subject Demographic details and Comments. When the information is entered select 'Continue'.
7. The PDF report saves in the default location: C:\Vitalograph\VitalPrint2.0\Reports

## **4. Power Management**

The asma-1 USB operates with 2 AAA 1.5V disposable batteries. If the battery symbol flashes the batteries should be replaced. Replace the batteries by removing the battery door on the underside of the device.

**Note:** *Dispose of used batteries safely.*

## **5. Cleaning & Hygiene**

The Vitalograph asma-1 USB is not designed or supplied as a 'sterile' device. Keep the device clean and dust free. If you suspect the device is damaged or is measuring incorrectly, contact your medical professional immediately.

The Vitalograph asma-1 USB should continue to give reliable measurements for up to three years in home use. It should then be replaced with a new device.

### **5.1. Cleaning in Single Patient Environment**

For single patient use, the plastic mouthpiece may be used.

Weekly cleaning of the mouthpiece, outside surfaces and flowhead of the device is recommended. A cloth impregnated with 70% isopropyl alcohol may be used. The reusable plastic mouthpiece may be washed in warm soapy water and then rinsed in clean water. The device should be cleaned before and after an extended period of storage.

## 5.2. Preventing Cross-Contamination of Subjects in Clinic use

For multi-patient use in a clinic or telemedicine environment Vitalograph recommends the use of Eco BVF filters or, if these aren't available then SafeTway mouthpieces may be used based on the customer own risk assessment and hygiene controls.

Before use by the next subject, the mouthpiece, outside surfaces and flowhead of the device should be cleaned with a cloth impregnated with 70% isopropyl alcohol. The device should be cleaned before and after an extended period of storage. If you suspect that a device intended for multi patient use has become contaminated, it should be replaced.

When used in the clinic environment, it is recommended that the device be replaced annually. There is no planned preventive maintenance for this medical device.

## 6. Fault Finding Guide

<b>Problem Fault Symptoms:</b>	<b>No flow measurements</b>
Possible Causes: (In probable order)	The batteries may be low. Replace the batteries.  The flowhead may be damaged. Check that the rotating vane is spinning freely.
<b>Problem Fault Symptoms:</b>	<b>Cannot read user interface</b>
Possible Causes:	The batteries may be low. Replace the batteries.

## 7. Customer Service

For further assistance, setting up, using or maintaining the device or to report unexpected operations or changes in performance, contact Vitalograph, using the contact information at the start of this manual. Also contact the healthcare provider on any changes to the performance of the device, as a precaution.

Service and repairs should be carried out only by the manufacturer, or by Service Agents approved by Vitalograph. Contact information for approved Vitalograph Service Agents may be found at the start of this manual.

Any serious incident that has occurred in relation to the device should be reported to Vitalograph or its Authorized Representative and the Regulatory Authorities of the country. Refer to the Vitalograph contact information at the start of this manual.

## 8. Consumables and Accessories













Cat. No	Description
28501	Eco BVF (100)
28572	Eco BVF + Disposable Noseclips (80)
40168	Plastic Mouthpiece 4000 series (20)
20303	Disposable Noseclips (200)
40167	Pouch Spare (x10)
20242	SafeTway Mouthpieces (200)
40079	USB Cable - 1M MINI-B to USB A







## 9. Disposal

The device and USB cable must be taken to separate collection at the product end-of-life. Do not dispose of these products as unsorted municipal waste. The pouch can be disposed of in unsorted municipal waste.

Used Eco BVFs and SafeTways, constitute minimally soiled waste from human healthcare and should be disposed of in line with local requirements. Eco BVFs are made from 100% polypropylene.

## 10. Explanation of Symbols

Symbol	Description
	Type BF equipment
VA	Power rating
v 	Direct current
	Instructions for Use; operating instructions
	Manufacturer
	Date of Manufacture (include date in format yyyy-mm-dd)
	The device must be taken to separate collection at the product end-of-life. Do not dispose of these products as unsorted municipal waste
	Serial Number
	Device Order Number
	Use by Date (Date format yyyy-mm-dd)
	Keep Dry
	Do not re-use
	Non sterile
	Recycle

Symbol	Description
	QR code - matrix bar code. All information in the bar code is included in the text under it
Other Labels	
	Battery status Battery status Full Battery status Half Battery status Quarter Battery status Empty (flashing)
	Blow Now Symbol
	Bad Test Symbol
	Memory 90% - 100% Full Icon Flashes when memory reaches 100%
	Transmit Report Symbol

## 11. Description of the Vitalograph asma-1 USB

The Vitalograph asma-1 USB is a medical device intended to give objective measures of lung function for help in managing asthma. It is intended to be used in a variety of professional healthcare environments, e.g. primary care, hospitals and occupational health centres as well as in the home. The device measures airflow out of the lungs when blown into as hard and fast as possible. The asma-1 USB can reveal narrowing of the airways well in advance of an asthma attack being felt by the asthmatic. Used mainly by persons with moderate to severe and persistent asthma, the asma-1 USB can help determine:

- When to seek emergency medical care
- The effectiveness of an asthma management and treatment plan
- When to stop or add medication, as directed by the physician

- What triggers the asthma attack (such as exercise-induced asthma)

### 11.1. Indications for Use

The Vitalograph asma-1 USB is a hand held respiratory monitor which measures subject respiratory parameters FEV1 and PEF. It is designed for lung function testing of adults and children, 5 years and older, in home and professional healthcare environments, e.g. primary care, hospitals and occupational health centres. The device is intended to be operated by the patient, under the supervision of a healthcare provider.

## 12. Technical Specification

<b>Product</b>	Respiratory Monitor asma-1 USB
<b>Model</b>	4000
<b>Dimensions</b>	109mm (length) x 63mm (width) x 42mm (height)
<b>Weight</b>	63g (not including batteries)
<b>Flow Detection Principal</b>	Stator/rotor
<b>Accuracy</b>	Better than $\pm 3\%$ (FEV1), $\pm 10\%$ (PEF)
<b>Back pressure</b>	Less than 0.15kPa/L/second @ 14L/s
<b>Measurement Range:</b>	PEF: 25 – 840 L/min BTPS FEV1: 0 – 9.99 L BTPS
<b>Maximum test duration</b>	1 second
<b>! Bad Test Criteria</b>	Time to Peak Flow >120ms or a cough detected in the first second
<b>Power Supply</b>	3V (2 x 1.5V AAA batteries)
<b>Battery Life</b>	3 months of use, 3 tests per day (Batteries near the end of their shelf life will have reduced capacity.)

<b>Product Life</b>	6 Years for the main device. The Eco BVF, SafeTway & nose clips are single use.
<b>Operating temperature range</b>	17–37°C
<b>Operating humidity range</b>	30%–75%
<b>Ambient pressure range</b>	850hPa–1060hPa
<b>Performance standards:</b>	ATS/ERS 2019, ISO 23747:2015, ISO 26782:2009
<b>Safety standards</b>	EN 60601-1, EN 60601-1-11
<b>EMC Standards</b>	EN 60601-2
<b>QA/GMP standards</b>	EN ISO 13485, FDA 21 CFR 820, CMDR SOR/98-282, JPAL, MDSAP.
<b>Communications</b>	USB2.0/3.0
<b>PC Requirements</b>	Windows® 7, Windows® 8 or Windows® 10

### 13. Contraindications, Warnings, Precautions and Adverse Reactions

1. No modification of this equipment is allowed. Any unauthorised changes to the device may compromise product safety and/or data and as such Vitalograph cannot be held responsible and the device will no longer be supported.
2. The device should only be used under the supervision of a healthcare professional.
3. The device is not designed as a sterile device. Always follow the safety guidelines given by the manufacturer of cleaning and disinfectant chemicals.
4. If used for multiple subjects, Vitalograph intends that a new Eco Bacterial Viral Filter (Eco BVF) be used for every subject to



prevent cross contamination. Using a new Eco BVF provides a significant level of protection of the subject, the device and the user against the risk of cross contamination during spirometry manoeuvres. An Eco BVF is for single use only.

5. Spirometry is a valuable tool that provides important information to clinicians which is used together with other physical findings, symptoms, and history to reach a diagnosis (ATS/ERS 2019). And as such, spirometry may support or exclude diagnosis, but it cannot make one.
6. Take care not to block the mouthpiece with the tongue or teeth during testing. A 'spitting' action or cough will give false readings.
7. Subject fatigue may occur during testing depending on the subject's characteristics e.g. age, health status. For safety reasons, testing should be preferably done in the sitting position, using a chair with arms and without wheels. Subject can also take a break between tests.
8. All values displayed are expressed as BTPS values.
9. Time zero is determined using the back-extrapolated method, from the steepest part of the curve.
10. Symptoms must take precedence over device measurements. If the patient at home thinks that the device is not reading correctly, they must advise the healthcare professional immediately.
11. Do not expose the device to liquids other than cleaning liquids specified.
12. Keep device dry. If the device gets wet, do not use it, and contact Vitalograph using the contact information at the start of this manual. Do not connect any part of this device to mains power as there is a risk of injury especially if the device is wet.
13. The device is not intended to be used in the presence of flammable liquids or gases, dust, sand or any other chemical substances.
14. Service and repairs should be carried out only by the manufacturer or by Service Agents specifically approved by Vitalograph.
15. RF communications equipment (including peripherals such as antenna cables and external antennas), which emit

- electromagnetic fields, should be used no closer than 30 cm (12 inches) to any part of the device, including cables specified by Vitalograph. Otherwise, degradation of the performance of this equipment could result.
16. The device is a Type BF applied part. The subject comes into contact with the device, mouthpiece, SafeTway or Eco BVF during use.
  17. The USB cable is a potential strangulation hazard. Adult supervision is required at all times, when a child is using the device.
  18. Take care during battery replacement. An AAA battery is a potential choking hazard for a small child. Adult supervision is required at all times, when a child is using the device. The battery door, when removed, has pointed corners which may present a risk of injury.
  19. The batteries should be removed if the device is intended to be stored or left unused for an extended period of time.
  20. Only approved accessories from the manufacturer should be used with the device. It is may be unsafe to use accessories, detachable parts and materials not described in this document.
  21. Non-Medical Electrical equipment used with the device, should comply with its relevant IEC or ISO standard.
  22. For the device to be used as intended, there is no requirement to clean the supporting computer. If cleaning is required to remove any visible soiling, this should be done as per the computer manufacturer's instructions.

#### 14. CE Notice

Marking by the symbol  indicates compliance of the Vitalograph Model 4000 asma-1 to the Medical Devices Directive of the European Community.

The Vitalograph Model 4000 asma-1 is intended for use in a variety of Home and professional healthcare environments, e.g. primary care, hospital wards and occupational health centres, except for near active high frequency surgical equipment and the RF shielded room of an ME system for magnetic resonance imaging, where the intensity of electromagnetic disturbance is high. The customer or

the user of the asma-1 should assure that it is not used in such an environment.

The Model 4000 asma-1 has been tested in accordance with:

EN60601-1:2006 + A1:2013

Medical electrical equipment. General requirements for basic safety and essential performance

EN 60601-1-11: 2015

Medical electrical equipment. General requirements for basic safety and essential performance. Collateral Standard: Requirements for medical electrical equipment and medical electrical systems used in the home healthcare environment.

EN 60601-1-2: 2015

Medical electrical equipment - Part 1-2: General requirements for basic safety and essential performance - Collateral Standard: Electromagnetic disturbances - Requirements and tests.

<b>EN 60601-1-2 - Emissions tests</b>		
<b>Emissions test</b>	<b>Compliance</b>	<b>Electromagnetic environment - guidance</b>
RF emissions CISPR 11	Group 1	The Model 4000 asma-1 uses RF energy only for its internal function. Therefore, its RF emissions are very low and are not likely to cause any interference in nearby electronic equipment.
RF emissions CISPR 11	Class B	The Model 4000 asma-1 is suitable for use in all establishments, including domestic establishments.

<b>EN 60601-1-2 Immunity tests</b>		
<b>Immunity test</b>	<b>Test level</b>	<b>Compliance level Reached</b>
<i>Electrostatic discharge (ESD)</i> <i>EN 61000-4-2</i>	<i>Contact: ± 8 kV</i> <i>Air: ± 2 kV,± 4 kV,</i> <i>± 8kV,± 15 kV</i>	<i>Contact: ± 8 kV</i> <i>Air: ± 2 kV,± 4 kV,</i> <i>± 8kV,± 15 kV</i>
<i>Radiated RF</i> <i>EN 61000-4-3</i>	<i>3 V/m</i> <i>80MHz to 2700MHz</i>	<i>3 V/m</i> <i>80MHz to 2700 MHz</i>
<i>Proximity fields from RF devices</i> <i>EN 61000-4-3</i>	<i>9 to 28V/m</i> <i>385 to 5785MHz</i> <i>As per Table 9</i> <i>EN60601-1-2:2015</i>	<i>9 to 28V/m</i> <i>385 to 5785MHz</i> <i>As per Table 9</i> <i>EN60601-1-2:2015</i>

Medical Devices may be affected by mobile RF communications equipment including cellular telephones and other personal or household devices not intended for medical facilities. It is recommended that all equipment used near the Vitalograph product comply with the medical electromagnetic compatibility standard and to check before use that no interference is evident or possible. If interference is suspected or possible, switching off the offending device is the normal solution, as is required in aircraft and medical facilities.

Medical electrical equipment needs special precautions regarding EMC and needs to be installed and put into service according to the EMC information provided.

## **15. FDA Notice**

**Caution: Federal Law restricts this device to sale by, or on the order of a physician.**

## 16. EU Declaration of Conformity

Product: Respiratory Monitor 4000, asma-1

Vitalograph hereby ensures and declares that the above product associated with these instructions for use, is designed and manufactured in accordance with the following QMS regulations and standards:

- European Medical Devices Directive (MDD) 93/42/EEC, as amended.

This device is classified as IIa per Annex IX of the MDD also meets the provisions of the Essential Requirements, Annex I, via compliance with Annex II of the Medical Devices Directive as per Article 11, section 3a, excluding point 4 of Annex II.

- EN ISO 13485 Medical devices. Quality management systems. Requirements for regulatory purposes.

Certifying Body: British Standards Institute (BSI).

BSI Notified Body #: 2797

Certificate Nos. CE 00772, MD 82182

Signed on behalf of Vitalograph (Ireland) Ltd.

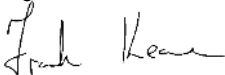

Frank Keane.

CEO, Vitalograph Ltd.

## 17. Guarantee

Subject to the conditions listed below, Vitalograph Ltd. and its associated companies, (hereinafter called the Company) guarantee to repair or at its option replace any component thereof, which, in the opinion of the Company is faulty or below standard as a result of inferior workmanship or materials. The conditions of this guarantee are:-

1. This Guarantee shall only apply to hardware defects which are notified to the Company or to its accredited distributor within 1 year of the date of purchase of the equipment, unless otherwise agreed in writing by the Company.
2. Software (meaning computer software, or user installable modules) is guaranteed for 90 days from the date of purchase.
3. The Company warrants that the software when correctly used in conjunction with the hardware will perform in the manner described in the Company's literature and user manuals. The Company undertakes to rectify at no expense to the customer any software failure notified within the period stated above, provided that the failure can be recreated and the software has been installed and used in accordance with the user manual. Notwithstanding this clause, the software is not warranted to be free of errors.
4. This Guarantee does not cover any faults caused by accident, misuse, neglect, tampering with the equipment, use of consumable items or parts not approved by the Company, or any attempt at adjustment or repair other than by personnel accredited by the Company, nor does it cover reinstatement of any configuration changes caused by the installation of any software.
5. If a defect occurs please contact the supplier from whom it was purchased for advice. The Company does not authorize any person to create for it any other obligation or liability in connection with Vitalograph® equipment.
6. This Guarantee is not transferable and no person, firm or company has any authority to vary the terms or conditions of this guarantee.
7. To the maximum extent permitted by law, the Company does not accept liability for any consequential damages arising out of the use of, or inability to use any Vitalograph® equipment.
8. This Guarantee is offered as an additional benefit to the Consumer's statutory rights and does not affect these rights in any way.

 **Vitalograph®**

**CE**  
2797

---